

Connect With Quality . . .

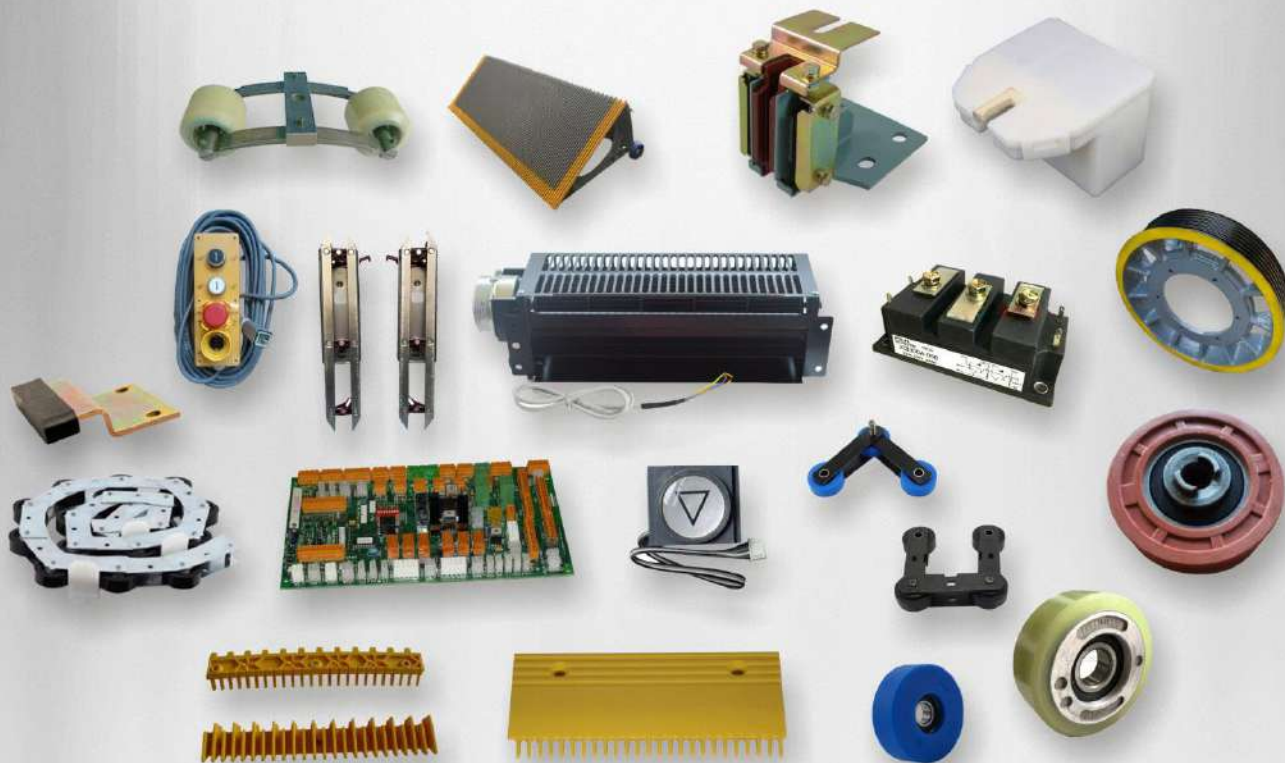

WWW.GNLINT.COM



Ningbo GNL Elevator Spare Parts Co.,Ltd.



Company profile

Ningbo GNL Elevator Spare Parts Co., Ltd.

Located in Ningbo City, China. Ningbo City is known as the home of the Elevator & Escalator spare parts in China. Ningbo is also an important port city located 220 kilometers (140 mi) south of Shanghai.

Why You Like Business With Ningbo GNL?

Ningbo GNL Elevator Spare Parts Co., Ltd. Started business with the great slogan "Connect with quality", Ningbo GNL never compromise with the quality of the spare parts. Ningbo GNL co-operates with the OEM brand and supplies the best of best quality parts to the customer. Ningbo GNL also customized any requirement parts for the customer.

Why Ningbo GNL Is Special?

Every Ningbo GNL family members have a great history of experience in elevator spare parts industry. Each member waiting 24/7 for best customer service. Any inquiry /message/information, get reply within 24 hour. A big inventory insure the most regular parts in stock and ship out within 48 hour after receiving the payment.

Why Business with Ningbo GNL is safe?

There is lot of local small company who generally offer the low quality and less price but when any problem happens, they have no ability to give any backup/recover/ solve the problem. But Ningbo GNL Elevator Spare Parts Co., Ltd. Is the master label big invest company in Ningbo City. China, and have fully ability to recover any problem if there is...



PRODUCT INDEX

Escalator Handril Belt	01
Escalator Wearing Strip	01
Escalator Step Chain	02-03
Escalator Automatic Oil Pump	04
GNL Display	04
Elevator Door Inverter	05
Elevator Rope Fastening	06
Elevator Traction Wheel	06-07

Elevator

KONE Elevator Parts	08-13
Mitsubshi Elevator Parts	14-21
OTIS Elevator Parts	22-33
Schindler Elevator Parts	34-37
ThyssenKrupp Elevator	38-39
LG SIGMA Elevator Parts	40-43
Toshiba Elevator Parts	44-45
HYUNDAI Elevator	46-47
Fujitec Elevator Parts	48-49
HITACHI Elevator Parts	50-53
Fermator Elevator Parts	54-55

Escalator

KONE Elevator Parts	56-59
Mitsubshi Elevator Parts	60-61
OTIS Elevator Parts	62-66
Schindler Elevator Parts	67-69
ThyssenKrupp Elevator	70
LG SIGMA Elevator Parts	71-72
Toshiba Elevator Parts	73-74
HYUNDAI Elevator	75-76
Fujitec Elevator Parts	77
HITACHI Elevator Parts	78-79



Escalator Handril Belt

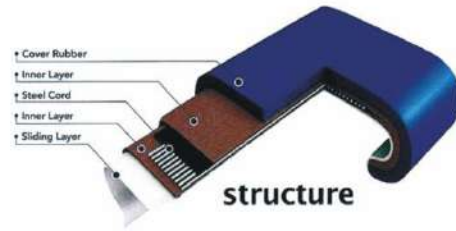
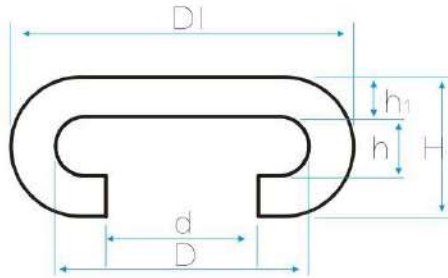

GNL MODEL	GNLHR-1	GNLHR-2	GNLHR-3	GNLHR-4	GNLHR-5	GNLHR-6	GNLHR-7	GNLHR-8	GNLHR-9	GNLHR-10	GNLHR-11	GNLHR-12	GNLHR-13	GNLHR-14	GNLHR-15
TYPE	SWE	SDS	OTIS-800	OTIS	J	GRF	GRF-1	XF	W-BT2	W-BT3	LG	LG-1	STD	KONE	E
d	33 ⁺³ ₋₁	39 ⁺³ ₋₁	39 ⁺² ₋₁	38 ⁺² ₋₁	41 ⁺² ₋₁	41 ⁺² ₋₁	40 ⁺² ₋₁	35 ⁺² ₋₁	40 ⁺¹ _{-0.5}	40 ⁺² ₋₁	39.5 ⁺² ₋₁	42 ⁺² ₋₁	40 ⁺² ₋₁	37.5 ^{+2.5} ₋₀	40 ⁺² ₋₁
D	62 ± 1	62 ± 1	60 ± 1	64 ± 1	62 ± 1	63 ± 1	63 ± 1	62 ± 1	64 ± 0.5	63.5 ± 1	63.5 ± 1	64.5 ± 1	63 ⁺² ₋₀	62.8 ^{+2.5} ₋₀	63 ⁺² ₋₀
DI	82 ± 1	80 ± 1	76 ± 1	82 ± 1	80 ± 1	80 ± 1	82 ± 1	82 ± 1	80 ± 0.5	80 ⁺³ ₋₁	82 ± 1	82 ± 1	80 ⁺⁰ ₋₁	79.2 ^{+2.5} ₋₀	80 ± 1
h	12 ± 0.8	10.6 ± 0.8	9.5 ± 0.8	16.5 ± 0.8	10 ± 0.8	10.6 ± 0.8	11.5 ± 0.8	14 ± 0.8	12 ± 0.5	10.6 ± 0.8	12.5 ± 0.8	16.5 ± 0.8	10 ^{+1.5} ₋₀	10.6 ± 0.5	10 ^{+1.5} ₋₀
h1	12 ± 1	9.5 ± 1	10 ± 1	9.5 ± 1	9.2 ± 1	10 ± 1	10.4 ± 1	12 ± 1	10 ^{+1.5} _{-0.5}	10.4 ± 1	12 ± 1	12 ± 1	10 ⁺⁰ ₋₁	9.5 ⁺¹ _{-0.5}	10 ± 1
H	34 ± 1	28.5 ± 1	28 ± 1	35.5 ± 1	27 ± 1	27.5 ± 1	31.7 ± 1	35 ± 1	30 ± 0.5	28.4 ± 1	33 ± 1	36 ± 1	28.5 ⁺⁰ ₋₁	28.15 ^{+1.5} ₋₁	28.5 ⁺¹ ₋₀



Escalator Wearing Strip

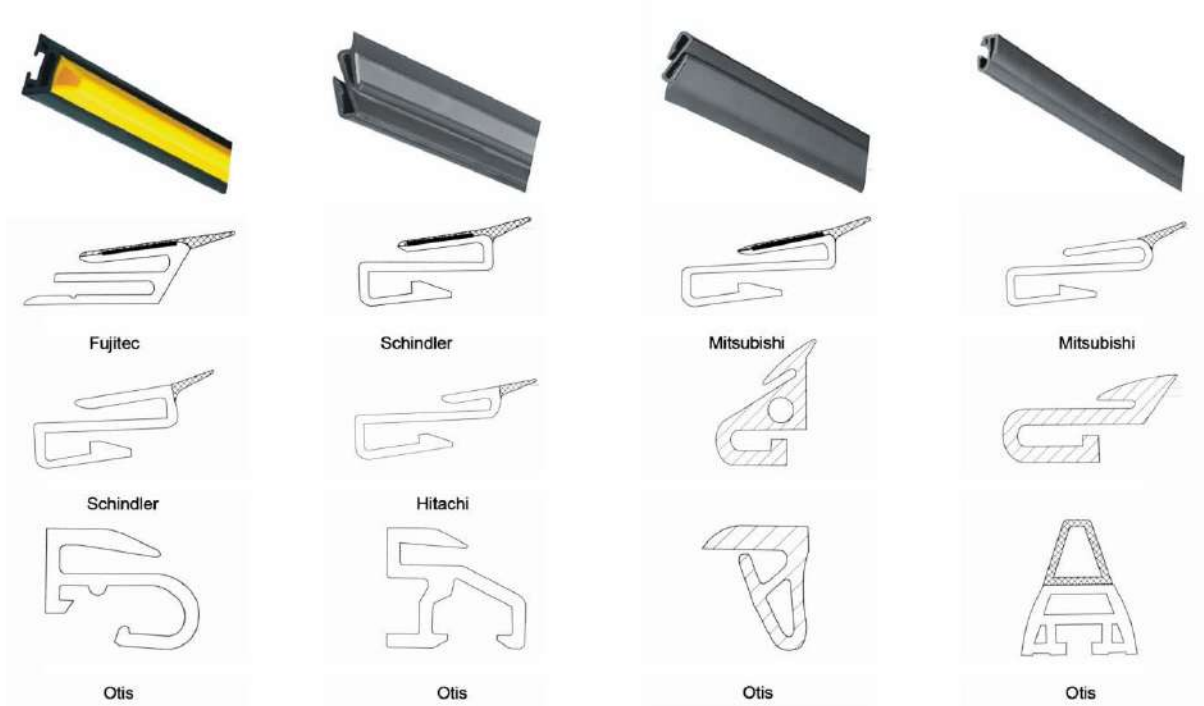

Escalator Step Chain

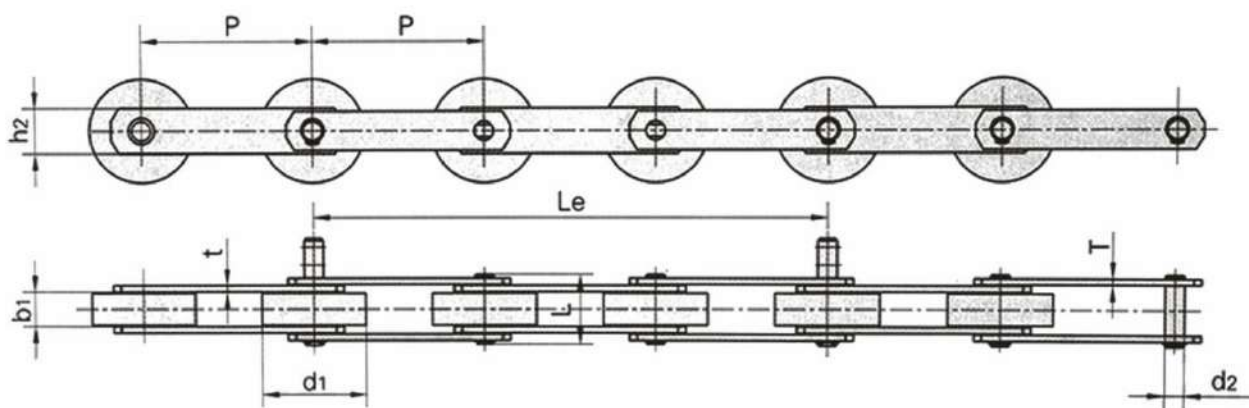

Model	Pitch	Roller diameter	Width between inner plates	Pin diameter	Pin length	Inner plater depth	Plate thickness	Distance between steps (three pitches)	Ultimate tensile strength	Average tensile strength	Weight per step
	P	d1 max	b1 min	d2 max	L max	h2	t/T max	Le	Q min	Q0	Q
	mm	mm	mm	mm	mm	mm	mm	mm	KN/LB	KN	Kg
GNLSCH-1	131.33	80.00	27.0	24.00	54.5	50.0	5.0	394.00	180.0/40465	198.00	3.700
GNLSCH-2	131.33	80.00	27.0	14.63	54.5	50.0	5.0	394.00	180.0/40465	198.00	2.480
GNLSCH-3	131.33	80.00	27.0	14.63	56.5	35.0	5.0	394.00	123.0/27651	150.0	2.310
GNLSCH-4	133.33	70.00	27.0	14.63	55.0	40.0	5.0	400.00	180.0/40465	198.00	2.450
GNLSCH-5	133.33	70.00	27.0	14.63	56.5	35	5.0	400.00	127.4/28640	140.1	2.380
GNLSCH-6	133.33	80.00	27.0	24.00	54.5	50.0	5.0	400.00	180.0/40465	198.0	3.530
GNLSCH-7	133.33	75.00	25.4	14.63	54.2	35	5.0	400.00	123/27651	135.3	2.160
GNLSCH-8	133.33	76.20	27.0	14.63	55.0	40	5.0	400.00	180/40465	198.0	2.500
GNLSCH-10	133.33	39.37	33.7	22.00	70.0	60	7.0/6.0	400.00	350/78683	385.0	4.776
GNLSCH-11	133.33	39.37	33.7	16.00	65.0	50	5.0	400.00	170/38217	187.0	3.360
GNLSCH-12	131.33	76.20	23.6	12.70	52.0	35	5.0	394.00	90/20232	99.0	2.050
GNLSCH-13	131.33	76.20	23.6	12.70	52.0	35	5.0	394.00	90/20232	99.0	2.050
GNLSCH-15	131.33	76.20	23.6	15.00	52.0	35	5.0	394.00	123/27651	135.3	2.200
GNLSCH-17	131.33	76.20	23.6	15.00	52.0	35	5.0	394.00	123/27651	135.3	2.200
GNLSCH-18	135.47	76.20	23.6	12.7/15	54.2	35	5.0	406.40	90/20232	99.0	2.050



Escalator Driving Chain

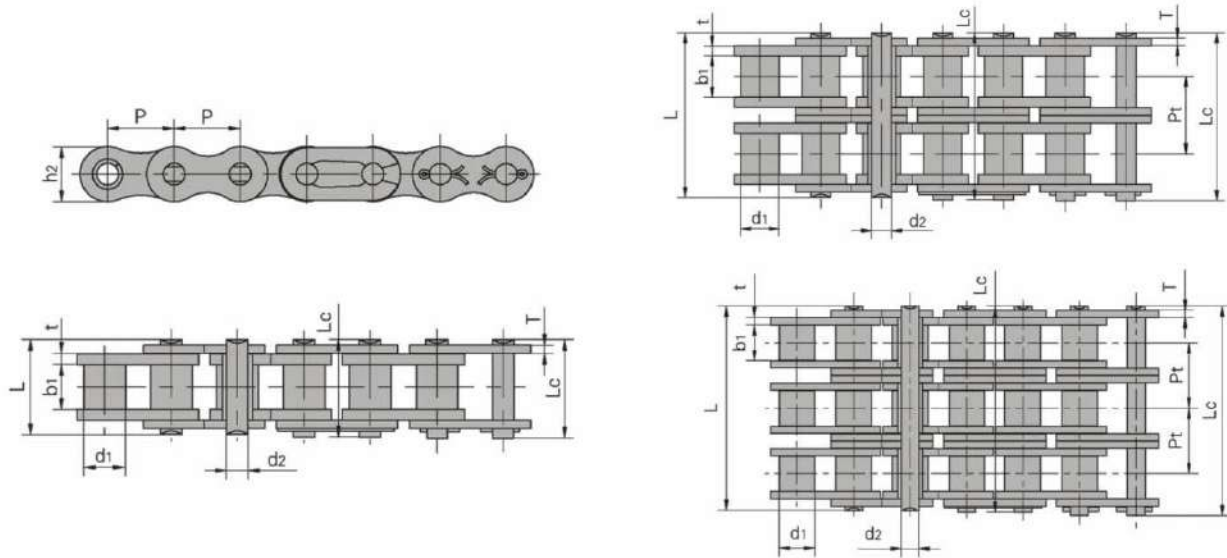

GNL Model	Type	Pitch	Roller diameter	Width between inner plates	Pin diameter	Pin length		Inner plate depth	Plate thickness	Transverse pitch	Ultimate tensile strength	Average tensile strength	Weight per meter
		P	d1 max	b1 min	d2 max	L max	Lc max	h2 max	t/T max	Pt	Q min	Q0	q
		mm	mm	mm	mm	mm	mm	mm	mm	mm	kN/lbf	kN	kg/m
GNLDVC-1	16A-2	25.40	15.88	15.75	7.92	62.7	64.3	24.00	3.25	29.29	113.40/25493	141.8	5.15
GNLDVC-2	16AFT-2	25.40	15.88	15.75	7.92	62.7	65.8	24.00	3.25	29.29	132.3/29742	165.4	5.51
GNLDVC-3	16B-1	25.40	15.88	17.02	8.28	36.1	37.4	21.00	4.15/3.10	-	60.0/13488	72.8	2.71
GNLDVC-4	16B-2	25.40	15.88	17.02	8.28	68.0	69.3	21.00	4.15/3.10	31.88	106.0/23829	133.0	5.42
GNLDVC-5	20A-2	31.75	19.05	18.90	9.53	76.4	80.5	30.00	4.00	35.76	177.00/39791	219.4	7.80
GNLDVC-6	20AFT-2	31.75	19.05	18.90	9.53	76.4	80.5	30.10	4.00	35.76	211.68/47587	262.5	8.09
GNLDVC-8	20A-3	31.75	19.05	18.90	9.53	112.2	116.3	30.00	4.00	35.76	265.5/59686	309.6	11.77
GNLDVC-9	20AFT-3	31.75	19.05	18.90	9.53	112.2	116.3	30.10	4.00	35.76	330/74186	395.0	12.10
GNLDVC-10	24A-2	38.10	22.23	25.22	11.10	95.8	99.7	35.70	4.80	45.44	254.00/57101	314.9	11.70
GNLDVC-11	20B-3	31.75	19.05	19.56	10.19	114.2	117.9	26.40	4.50/3.50	36.45	250/56202	290.0	10.82
GNLDVC-12	24B-2	38.10	25.40	25.40	14.63	101.7	106.2	33.20	4.50/3.50	48.36	280.0/62946	319.2	13.40
GNLDVC-13	100SLR-2	31.75	19.05	18.90	9.53	76.4	80.5	30.00	4.00	35.76	173.4/39399	190.0	7.89
GNLDVC-14	16BSLR-2	25.40	15.88	17.02	8.28	68.0	69.3	21.00	4.15/3.10	31.88	106.0/23829	133.0	5.42

Escalator Automatic Oil Pump

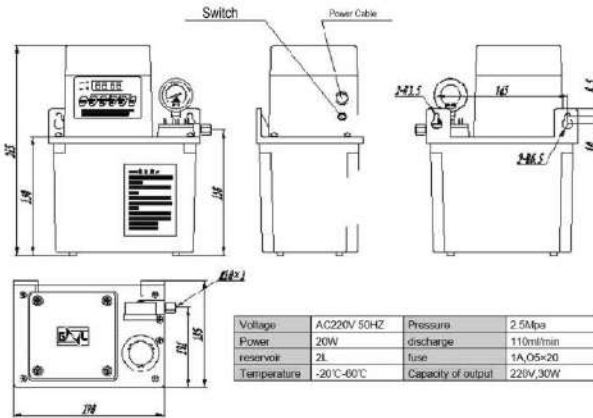

Escalator Oil Brush



GNL Display



GNLTC-HCB-R1

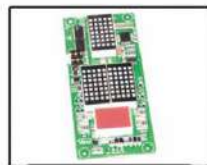

GNLTC-HCB-H

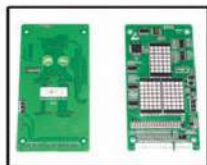

GNLTC-HCB-R1-BO-BCD



GNLTC-HCB-R1-BO



GNLTC-HCB-R1-BCD-HX

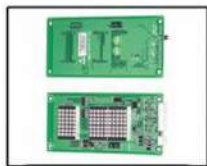

GNLTC-HCB-R1-HX



GNLTC-HCB-R1-BCD



GNLTC-HCB-L-BO



GNLTC-HCB-T7-TPJ-YY



GNLTC-HCB-T4-3-BO



GNLTC-HCB-LG-BO



GNLTC-HCB-L



GNLTC-HCB-D5



GNLTC-7SEG-2LD

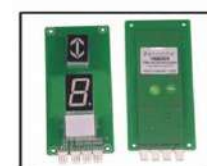

GNLTC-7SEG-1LD



Elevator Door Inverter



You can modify the parameters, monitor the working status and run or stop the controller by operating the operation panel shown.

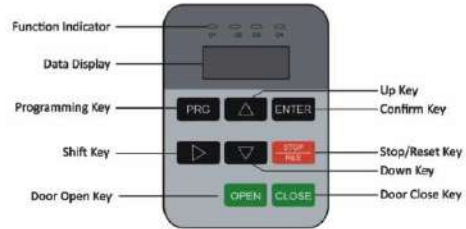

Main Features of GNL Door Machine Controller

- Sensorless vector control (SVC) and Closed-Loop Vector Control (CLP).
- Matched with asynchronous motor and PMSM.
- 2 kinds of motor auto-tuning mode are available.
- Support 2 control modes (speed control and distance control).
- Slip compensation & Torque booster.
- Door width auto-tuning.
- Torque setting for door width auto-tuning or initial running.
- Special design for door machine controller of lift/elevator.
- Automatic demonstration is supported.
- Overload protection (1 minute for 150% of rated current, 1 second for 180% of rate current).
- Automatic identification upon hindering.

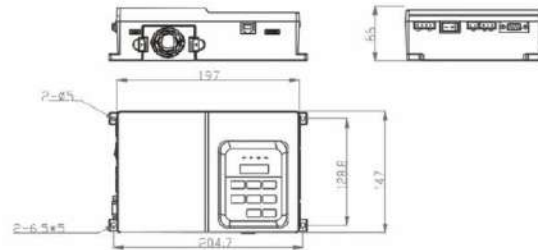

Terminal	Name	Description
L, N	Single-phase power input terminals	Provide single-phase 220 VAC power supply.
P, PB	Reserved	These terminal are generally reserved, but they can be connected with the external regen. resistor if required.
U, V, W	Controller output terminals	Connect the three-phase motor.
⊕	Grounding terminal	Must be grounded.

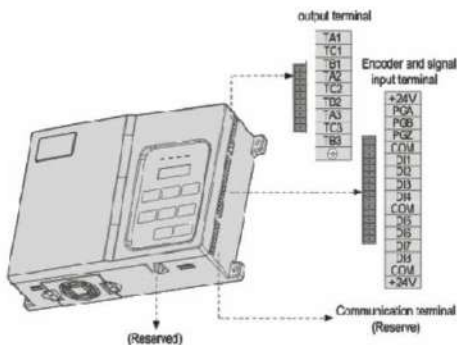
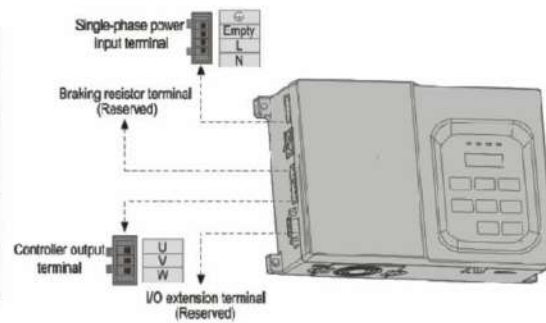

Name	Type	Mark	Function Description	Remarks
Door state output terminal	Relay output and grounding	TA1/TR1/TC1 TA2/TR2/TC2 TA3/TR3/TC3	Relay output	1. TA-TB: normally closed (NC) TA-TC: normally open (NO) Contact capacity: 250 ACV, 3A; 30 VDC, 1 A 2. Insulation voltage class between contact and control circuit: 2.5 kVAC
Encoder and control signal input terminal	Internal 24 V power supply	+24V	24 VDC power supply	Used as the non-contact switch or power supply for the encoder. Maximum output current: 200mA
		COM	24 V power common	Isolated with the internal 24 V power common terminal of the controller
	Encoder input	PGA	Encoder phase A	Open-collector output or push-pull output
		PGZ	Encoder phase Z	
Reserved	Digital input	D1 to D8	Digital signal input	Optocoupler isolation, low level active Input voltage range: 0-30 VDC Input impedance: 3.3 kΩ
	Software burning interface	RS45	Software burning interface	-

Elevator Rope Fastening



SPRING ROPE FASTENING

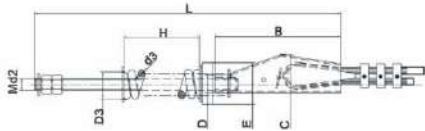

RUBBER ROPE FASTENING



FLEXIBLE ROPE FASTENING

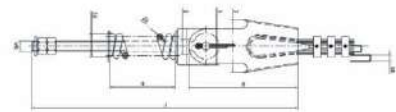

Elevator Traction Wheel



Kone
655 × 6 × 13



Kone
540 × 6 × 13



Mitsubishi
760 × 12 × (5)(6)(7)
780 × 14 × (5)(6)(7)
760 × 16 × (5)(6)



Mitsubishi
710 × 12 × (5)(6)(7)
710 × 14 × (5)(6)(7)
710 × 16 × (5)(6)



Mitsubishi
560 × 12 × 4
610 × 12 × 4
680 × 12 × 4



Mitsubishi
480 × 12 × 3
560 × 12 × 3
620 × 12 × 3
680 × 12 × 3



Mitsubishi
620 × 10 × (4)(5)(6)



Mitsubishi
400 × 8 × (4)(5)(6)
410 × 8 × (4)(5)(6)



Mitsubishi
1KT860 × 12 × (4)(5)(6)
1KT760 × 12 × (4)(5)(6)



Mitsubishi
EH5100 YA047B243 500 × 12 × 10
YA090B828-02 620 × 12 × 8
YA090B828-05 620 × 12 × 8



Mitsubishi
EMJ580TB 880 × 16 × (6)(7)



Mitsubishi
720 × 6/7 × 12/14



Mitsubishi
620 × 4/6 × 12
635 × 4/6 × 12
650/660 × 4/6 × 12



OTIS
540 × 5/4/3 × 13
630 × 5/4 × 13
658 × 5/4 × 13
570 × 13 × (3)(4)(5)



OTIS
650 × 13 × 5
650 × 16 × (4)(5)



OTIS
405 × 10 × (5)(6)



OTIS
700 × 13 × (5)(6)



OTIS
575 × 3 × 13
620 × 3 × 13
700 × 3/4 × 13
630 × 4/5 × 13

595 × 3 × 13
640/660 × 3 × 13
720 × 3/4 × 13



OTIS
755 × 4/5/6 × 13



OTIS
615 × 8 × 13
φ 650 × 6 × 13



Elevator Traction Wheel



Schindler
570×4/5/6×13
650×4/5/6×13 (A220)
450×11×(4)(5)(6)
570×11×(4)(5)(6)(7)
640×11×(4)(5)(6)(7)
640×13×(4)(5)(6)(7)



Schindler
570×13×(4)(5)(6)(7)(8)
640×13×(4)(5)(6)(7)(8)
715×13×(4)(5)(6)(7)(8)
715×16×(4)(5)(6)(7)(8)



Schindler
565×6/5/4×13
720×4/5/6/7×13
642×6/7×13/16
905×6×13
715×16×(4)(5)(6)(7)(8)
900×16×(5)(6)(7)(8)

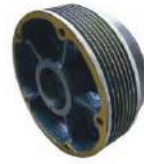

Schindler
GH330 570×13×7
P420 900×13×(5)(6)(7)



Schindler
565×6/5×13



Schindler
755×6/5×13
664×6/5×13



Schindler
565×6/5/4×13
720×4/5/6/7×13
642×6/7×13/16
905×6×13



XINDA
635×4/5/6×13



Hitachi
515×12×(3)(4)



Hitachi
615×12×(5)(6)(7)



Hitachi
655×16×7



Hitachi
715×12×(6)(7)



Hitachi
615×4/5/6×12
575/515×3×12



Hitachi
720×5/6×12



LG-Sigma
505×12×(4)(5)(6)



LG-Sigma
605×4/5×12



LG-Sigma
605×4/5×12



LG-Sigma
850×5×16



LG-Sigma
716×5/6/7×12



LG-Sigma
625/635×5/6×12



LG-Sigma
625×5/6/7×13



Toshiba
585×4/5/6×12
585×5×14
675×12×(3)(4)



Toshiba
580×5×14
680×12×(5)(6)



Toshiba
635×4/5/6×12
640×13×7



Thyssenkrupp
775×13×7



Thyssenkrupp
565×5/6×13



Thyssenkrupp
700×5/6×13



Thyssenkrupp
600×5/6×13



Thyssenkrupp
680×6×13



Thyssenkrupp
545×7×13 645×7×10
615×7×13



Fujitec
815×13×7
640×13×7



Fujitec
690×13×(5)(6)



Fujitec
775×13×7



Fujitec
715×140×6/5×12



Hyundai
776×6×13

KONE Elevator Parts



Elevator



KNE6001



KNE6002



KNE6003



KNE6004



KNE6005



KNE6009



KNE6010



KNE6018



KNE6019



KNE6020K



KNE6021



KNE6022



KNE6023



KNE6024



KNE6026



KNE6027



KNE6028



KNE6029



KNE6030



KNE6031



KNE6034



KNE6035



KNE6036



KNE6037



KNE6038



KNE6040



KNE6042



KNE6043

GNL Model	Fermator OEM /Model	Product Name	Product Description
KNE6001	KM601278H03	CAR DOOR BELT	
KNE6002	M863050G005H091	Push Button	
KNE6003	KM863050G006H002	Push Button	
KNE6004	KM863050G069H091	Push Button	
KNE6005	KM724409A31AD	Push Button	
KNE6009	KM863051G069H009	Push Button	
KNE6010	KM853343H04	Push Button	
KNE6018	ES0312159	Door Controller	
KNE6019	KM927043	Door Lock	
KNE6020K	M601107G03	Door Lock Wheel	31*17.5 ID:12
KNE6021	IT1332130	Door Lock Wheel	31*17.5 ID:15.5
KNE6022	3201.05.0013	Door Lock Wheel	40*15 ID:12
KNE6023	KM2L2M2200023	Door Lock	
KNE6024	FIA102608	Door Contact	
KNE6026	KM601107G02	Door Lock Wheel	31*19 ID:16
KNE6027	KM2L1M050037 / 3215.05.0037	Door Lock Wheel	32.7*14.5 ID: 8.2/17.3
KNE6028	KM89717G08	Door Motor	
KNE6029	KM89717G06	Door Motor	
KNE6030	KM602748G04	Door Motor	
KNE6031	KM601370G04	Door Motor	
KNE6034	KM392900G01	Door Slider	61*68*12
KNE6035	KM470560G01	Door Slider	71*15*12
KNE6036	KM442016G01	Door Slider	
KNE6037		Door Vane	
KNE6038	KM601500G15	Door Vane	
KNE6040	KM51045780	QVW2-06-2MHT Encoder	200VAC, 190W, 0.84A, 1250rpm
KNE6042	KM255063	Fan	
KNE6043	KM949120	Guide Shoe insert	16mm



KONE Elevator Parts

Elevator



KNE6044



KNE6045



KNE6046



KNE6047



KNE6048



KNE6049



KNE6050



KNE6051



KNE6052



KNE6053



KNE6054



KNE6055



KNE6056



KNE6057



KNE6058



KNE6059



KNE6060



KNE6061



KNE6062



KNE6063



KNE6064



KNE6066



KNE6067



KNE6068

GNL Model	Kone OEM / Model	Product Name	Product Description
KNE6044	KM50057317	Guide Shoe insert	10mm
KNE6045	ZK10722	Guide Shoe insert	128*34 16mm
KNE6046	ZK10721	Guide Shoe insert	128*34 10mm
KNE6047	ZK10671	Guide Shoe	120*22*29
KNE6048	KM850220G01	Guide Shoe	
KNE6049	KM850220G01	Guide Shoe	
KNE6050	KM652535G03	Guide Shoe Roller	125*26*2 6003
KNE6051	KM581274G03	Guide Shoe Roller	150*38*2 6003 ID:17
KNE6052	KM86789G02	Guide Shoe Roller	80*28*2 6203
KNE6053	KM51141169	Guide Shoe insert	131*22*16
KNE6054	KM652437G05	Guide Shoe insert	80*25*5
KNE6055	KM85119G16	Guide Shoe insert	140*30*16
KNE6056	KM51141168	Guide Shoe insert	131*22*9
KNE6057	KM652435G16	Guide Shoe	
KNE6058	KM581271G19	Guide Shoe Roller	Rated Speed: 3.5m/s, Roller:150mm
KNE6059	ZK10673	Guide Shoe	L=80mm, For TK5A Guide Rail
KNE6060	ZK11070	Oil Can	Square
KNE6061	KM811491G01	Tachometer	MX05/MX06/MX10 CABLE=5000MM
KNE6062	KM851932G02	Landing Operating Panel	
KNE6063		Vertical Display	
KNE6064		Horizontal Display	
KNE6066	KM740136G02	Landing Operating Panel	
KNE6067	KM1353633C04	Landing Operating Panel	
KNE6068	KM740136G03	Landing Operating Panel	

KONE Elevator Parts



Elevator



KNE6069



KNE6070



KNE6071



KNE6072



KNE6073



KNE6074



KNE6075



KNE6076



KNE6077



KNE6078



KNE6079



KNE6080



KNE6081



KNE6082



KNE6083



KNE6084



KNE6085



KNE6086



KNE6087



KNE6088



KNE6089



KNE6090



KNE6091



KNE6092

GNL Model	Kone OEM / Model	Product Name	Product Description
KNE6069	KM601106G01	Hanger Roller	94*19 6203 GD:84.5
KNE6070	ES0312251	Hanger Roller	62*16 6203 GD:52 ID:17
KNE6071	KM89350G01	Hanger Roller	44*12 M8 GD:38 ID:12
KNE6072	KM960310	Hanger Roller	74*16 6203 M10 GD:64
KNE6073	KM601106G02	Hanger Roller	94*19 6203 GD:84.5
KNE6074	KM949245	Door Under Roller	46*16 6001 GD:39 6G-M12
KNE6075	KM50085094	SELCOM Door Under Roller	43*16 6202 with Eccentric Shaft
KNE6076	KM1356260	Hanger Roller	44*16 GD:38 M10
KNE6077	KM923130	Door Under Roller	36.5*15 GD:31 6G-M10
KNE6078	KM923131	Door Under Roller	44*12 GD:38 M8
KNE6079		Door Under Roller	46*17 6201 GD:39
KNE6080	KM268250 / 3201.05.0032	Selcom Hanger Roller	56*15.5 6202
KNE6081	WK48898G02	Roller	30*12 608Z
KNE6082	DE91124 / 3201.05.0010	SELCOM Wheel	64*11*6202 ID:10
KNE6083		Wheel	50*12 6002 GD:43.5 ID:10
KNE6084	KM50054911	Wheel	48*9 608 GD:40 ID:8
KNE6085	KM89628G02	Car Door Roller	50*14 6201 M8
KNE6086	KM61501G12	Hanger Roller	59.6*13 6002Z
KNE6087	KM61501G13	Hanger Roller	59.6*13 6002Z
KNE6088	KM926946	Hanger Roller	68*17 6203Z
KNE6089	KM85495G01	Hanger Roller	70*17 6203Z
KNE6090	KM616655G01	Hanger Roller	85*19 6203Z
KNE6091	KM916131 / 3201.05.0032/C	Hanger Roller	56*15.5 6202
KNE6092	KM89628G02	Hanger Roller	56*16 M10



KONE Elevator Parts

Elevator



KNE6093



KNE6094



KNE6095



KNE6165



KNE6166



KNE6167



KNE6168



KNE6169



KNE6171



KNE6006



KNE6007



KNE6008



KNE6014



KNE6015



KNE6016



KNE6017



KNE6096



KNE6097



KNE6098



KNE6099



KNE6100

GNL Model	Kone OEM / Model	Product Name	Product Description
KNE6093	KM953503G21	KDL16L Drive Module	14A 400V
KNE6094	KM273449	Light Curtain	
KNE6095	KM897294	Light Curtain	
KNE6165	KM650808G01	Tachometer Wheel	Φ37.3X30 ID:11
KNE6166	KM51273842	Door motor Belt Roller	35*37
KNE6167	KM740336G01	Magnetic Sensor	MONOSTABLE: "NO" 61U, 61N & 30
KNE6168	KM713227G01	Magnetic Sensor	MONOSTABLE: 77U, 77N
KNE6169	KM86420G02	Inductor Sensor	Replaced By KM86420G03
KNE6171	KM982792G33	Tachometer	
KNE6006	KM724760G01	Push Button	
KNE6007	KM612910G01	Push Button	
KNE6008	KM617712G05	Push Button	
KNE6014	KM601810G01	Door Controller	
KNE6015	KM606810G01	Door Controller	
KNE6016	KM602810G02	Door Controller	
KNE6017	KM603810G01	Door Controller	
KNE6096	KM713140G04	LCEREC PC Board	
KNE6097	KM1349446G01	Display Board	
KNE6098	KM713140G05	PC Board	
KNE6099	KM713730G01	LCE CEB ASSEMBLY PC Board	
KNE6100	KM713720G11	LCE COB PC Board	

KONE Elevator Parts



Elevator



KNE6101



KNE6102



KNE6103



KNE6104



KNE6105



KNE6106



KNE6107



KNE6108



KNE6110



KNE6111



KNE6112



KNE6113



KNE6114



KNE6115



KNE6116



KNE6117



KNE6118



KNE6120



KNE6121



KNE6122



KNE6123



KNE6124



KNE6125

GNL Model	Kone OEM / Model	Product Name	Product Description
KNE6101	KM166628G01	SPEED REFERENCE PC Board	
KNE6102	KM713730G02	LCE CEB PC Board	
KNE6103	KM606810G02	Door Operate PC Board	
KNE6104	KM602810G01	Door Operate PC Board	Replaced By KM606040G01
KNE6105	KM713110G01	LCECAN PC Board	
KNE6106	KM713150G01	LCEOPT ASSEMBLY PC Board	
KNE6107	KM713150G11	LCEOPT ASSEMBLY PC Board	
KNE6108	KM713180G11	LCEGTW ASSEMBLY PC Board	
KNE6110	KM713700G01	LCEFCB ASSEMBLY PC Board	
KNE6111	KM713100G01	LCECPU MONOSPACE REV 2.5 PC Board	
KNE6112	KM713710G01	LCECCB CAR BOX PC Board	Replaced By KM50025436G01
KNE6113	KM713710G11	LCECCB CAR ROOF PC Board	
KNE6114	KM713710G51	LCE V3F16 PC Board	Replaced By KM50025436G11
KNE6115	KM713930G01	MAIN CIRCUIT DRIVE PC BOARD	
KNE6116	KM612012G01	LCE BRAKE CONTROL MODULE PC Board	
KNE6117	KM763600G01	LOPCB LCE PC Board	
KNE6118	KM763600G02	LOP-CB ASSEMBLY PC Board	
KNE6120	KM773380G04	LCECPU40 ASSEMBLY PC Board	
KNE6121	KM774150G01	V3F16L DCBN ASSEMBLY PC Board	
KNE6122	KM713700G01	LCEFCB ASSEMBLY PC Board	
KNE6123	KM763640G01	V3F18 LCECPU NC PC Board	
KNE6124	K2416G03	Landing Display Board	
KNE6125	KM654341G03	PCB ASSEMBLY 654341G03 REV 0.12 PC Board	



KONE Elevator Parts

Elevator



KNE6126



KNE6128



KNE6129



KNE6130



KNE6131



KNE6132



KNE6133



KNE6134



KNE6137



KNE6138



KNE6139



KNE6140



KNE6141



KNE6142



KNE6144



KNE6146



KNE6147

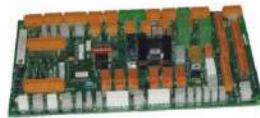

KNE6149



KNE6150



KNE6153



KNE6158



KNE6159



KNE6161



KNE6163



KNE6173

GNL Model	Kone OEM / Model	Product Name	Product Description
KNE6126	KM713550G01	Display Board	
KNE6128	KM713560G01	Car Display Board	
KNE6129	KM853300G05	Car Display Board	
KNE6130	KM853320G01	Landing Display Board	
KNE6131	KM863170G03	Display Board	
KNE6132	KM863180G02	Direction Display Board	
KNE6133	KM863210G01	Display Board	Replaced By KM50017286G01
KNE6134	KM863270G01	Landing Display Board	
KNE6137	KM781380G01	V3F25/V3F18 HCBN ASSEMBLY PC Board	
KNE6138	KM713160G01	LCEADO RESOLVE 100 PC Board	Replaced By KM50006052G01
KNE6139	KM713120G01	LCE230 PC Board	
KNE6140	KM713130G01	LCEKNX INTERFACE PC Board	
KNE6141	KM713700G11	LCEFCB ASSEMBLY PC Board	
KNE6142	A3J16426	Display Board	
KNE6144	KM713720G01	LOCAL LCECOB COP PC Board	
KNE6146	KM713730G11	LCE CEB ASSEMBLY PC Board	
KNE6147	KM713730G12	LCECIB PC Board	
KNE6149	KM802890G11	LCECCBN PC Board	Replaced By KM802890G12
KNE6150	KM713560G02	Display Board	
KNE6153	KM853320G03	LCI Display Board	Replaced By KM1349446G03
KNE6158	KM772850G02	F2KMUL PC Board	Replaced By KM981828G11
KNE6159	KM713900G01	V3F16 DRIVE CONTROLPC Board	
KNE6161	KM863270G02	AVDMAT2 Display Board	Replaced By KM50017290G02
KNE6163	KM50025436G31	LCECCBe ASSEMBLY PC Board	
KNE6173	KM878240G01	Service Tool / Test Tool	

Mitsubshi Elevator Parts



Elevator



GNL Model	Mitsubshi OEM / Model	Product Name	Product Description
MTE4001	LHB-052A	Push Button	12V/24V
MTE4002	J-M5497-01	Push Button	12V/24V
MTE4003	J-M5498-02	Push Button	12V/24V
MTE4004	DA345G04 / MTD345	Push Button	12V/24V
MTE4005	DA411G03 / MTD411	Push Button	12V/24V
MTE4006	DA482B102-A / MTD482	Push Button	12V/24V
MTE4007	YE601B517A / LHB-005B	Push Button	12V/24V
MTE4008	YE601B507A / LHB-006B	Push Button	12V/24V
MTE4009	YE601B557A / LHB-007B	Push Button	12V/24V
MTE4010	YE601B558A / LHB-008B	Push Button	12V/24V
MTE4011	LHB-051AG05 / LHB-G05	Push Button	12V/24V
MTE4012	DA211G01 / DA160	Push Button	12V/24V
MTE4013	DA211G02	Push Button	12V/24V
MTE4014	P235083B178G02	Push Button	12V/24V
MTE4015	C5MS-1W12D	Push Button	12V/24V
MTE4016	DA511G01	Push Button	12V/24V
MTE4017	DA340 G02	Push Button	12V/24V
MTE4018	DA180 G02	Push Button	12V/24V
MTE4020	X65AC-01	Encoder	
MTE4021	X65AC-31	Encoder	
MTE4022	PKT1045-512-J30F	Rotaty Encoder	
MTE4023	X65AC-22 / SBH-4096-6MD	Encoder	
MTE4024	BH752Y922H03 / SD-N50	Contactor	
MTE4025	SD-N35	Contactor	
MTE4026		Door Closer Weight Rope	



Mitsubshi Elevator Parts

Elevator



GNL Model	Mitsubshi OEM /Model	Product Name	Product Description
MTE4027		Door Closer Weight	800mm/900mm/1000mm
MTE4030		Door Closer Weight Chamber	1370/1470/1570/1770mm
MTE4031		Landing Door Hanger	
MTE4032		Car Door Hanger	
MTE4133		Hanger Roller Without Shaft	56*14*6201
MTE4134		Hanger Roller With Shaft	56*14*6201 M10
MTE4135		Hanger Roller Without Shaft	72*15*6202
MTE4136		Hanger Roller With Shaft	72*15*6202 M10
MTE4137		Cargo Lift Hanger Roller	84*17 6204
MTE4139		Guide Roller	38*12 6201 M8
MTE4140		Guide Roller	25*10 M8
MTE4243		Aluminum Roller	128*14
MTE4244		Door Vane Roller	90*11*6200
MTE4245		Door Vane Roller	70*12*6200
MTE4246		Door Vane Roller	25*17, M8
MTE4247		Door Vane Roller	46*13 ID:12
MTE4248	OLX04001	Door Vane	
MTE4249		Door Vane	
MTE4250		Door Vane	
MTE4251	YA06B727G10	Door Vane	
MTE4252	HOPE-IIG	Door Vane	
MTE4253	HA14101A1	Door Vane	
MTE4254		Counter Guide Shoe	
MTE4255		Counter Guide Shoe With Base	
MTE4256		Guide Shoe	
MTE4257		High Speed Guide Shoe	2.5m/s
MTE4258		Guide Shoe	
MTE4259		Guide Shoe Insert	120*308 10/16mm
MTE4260		Guide Shoe Insert	230 16/10mm
MTE4261		Guide Shoe Insert	40*70 16/10mm
MTE4262		Guide Shoe Insert	One 230*35*9, Two 230*30*9
MTE4263		Guide Shoe Insert	One 230*35*8, Two 230*30*12.5

Mitsubishi Elevator Parts



Elevator



MTE4264



MTE4265



MTE4266



MTE4267



MTE4268

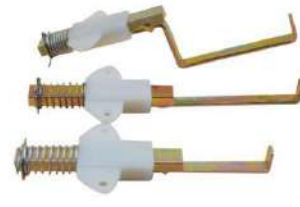

MTE4269

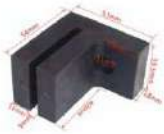

MTE4270



MTE4271



MTE4272



MTE4273



MTE4274



MTE4275



MTE4276



MTE4277



MTE4278



MTE4279



MTE4280



MTE4281



MTE4282



MTE4283



MTE4284



MTE4285



MTE4286



MTE4287

GNL Model	Mitsubishi OEM /Model	Product Name	Product Description
MTE4264		Guide Shoe Roller	80*25 6203
MTE4265		High Speed Roller Guide Shoe	
MTE4266		High Speed Guide Shoe Roller	200*32*6203
MTE4267		Guide Shoe Roller	114*22*6203
MTE4268		Guide Shoe Roller	76*22*6203
MTE4269		Door lock hook	
MTE4270		Damping Pad	
MTE4271	YA098C118G01	Door Slider	
MTE4272	FB-9B	Fan	110V/220V
MTE4273	FB-1042B	Fan	110V/220V
MTE4274	ZQF-330	Fan	110V/220V
MTE4275	FB-25D	Round Fan	110V/220V
MTE4276		Car top grip board	Left / Right
MTE4277		161 Door Lock	Left / Right
MTE4278		161 Door Lock Set	Left / Right
MTE4279		Door Lock	Left / Right
MTE4280	YTL-161A	Cargo Lift Door Lock	Left / Right
MTE4281	LD-161A	Cargo Lift Door Lock Set	Left / Right
MTE4282	GS75-11	Door Lock Set	Left / Right
MTE4283		161 Door Lock Contact	
MTE4284		Door Lock Contact	
MTE4285		Door Lock Contact	
MTE4286		DS-131 Car Door Switch	
MTE4287		DS-121 Car Door Switch	



Mitsubshi Elevator Parts

Elevator



MTE4288



MTE4290



MTE4291



MTE4292



MTE4293



MTE4294



MTE4295



MTE4296



MTE4297



MTE4298



MTE4299



MTE4300



MTE4301



MTE4302



MTE4306



MTE4307



MTE4308



MTE4309



MTE4310



MTE4311



MTE4312



MTE4313



MTE4315



MTE4316



MTE4317



MTE4318



MTE4319

GNL Model	Mitsubshi OEM /Model	Product Name	Product Description
MTE4288	GNL-S3-1370	imited Switch	
MTE4290	LXP1-020-1A / 3SE3-02-1A	Limite Switch	
MTE4291	V-155-1C25	Limite Switch	
MTE4292	S3-1375	Limite Switch	
MTE4293	Z-15GW-B	Micro Switch	
MTE4294	D4N-2A20	Limite Switch	
MTE4295	YZ-TR236-11Y	Limite Switch	
MTE4296	SND4111-SP-C-R	Limite Switch	
MTE4297	YZ-TV231-11Yr	Limite Switch	
MTE4298	LXP1(3SE3)-100/0GA	Limite Switch	
MTE4299	LXP1-100/1D	Limite Switch	
MTE4300	AZ-06	Door Contact Switch	
MTE4301	AZ-05	Door Contact Switch	
MTE4302	AZ-051	Door Contact Switch	
MTE4306	SK-C	Power Lock	
MTE4307	YE601B609	Power Lock	
MTE4308		161 Door Lock Roller	
MTE4309		162 Door Lock Roller	45*13 6002RS
MTE4310		163 Door Lock Roller	
MTE4311		Triangular Lock	
MTE4312	B286858	Triangular Key	
MTE4313		Power Lock	Key:2801/2802/2803
MTE4315	YA038B139G02	Oil Can	
MTE4316	P127001B000G01	Oil Can	
MTE4317		Oil Can	
MTE4318	RL-250	Oil Can	
MTE4319		Oil Collector Box	

Mitsubshi Elevator Parts



Elevator



MTE4320



MTE4321



MTE4322



MTE4323



MTE4325



MTE4326



MTE4327



MTE4328



MTE4329



MTE4330



MTE4331



MTE4332



MTE4333



MTE4334



MTE4335



MTE4336



MTE4337

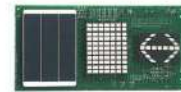

MTE4339

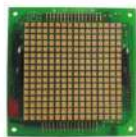

MTE4348



MTE4349



MTE4353



MTE4355

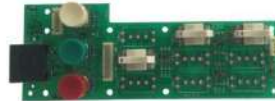

MTE4356

GNL Model	Mitsubshi OEM /Model	Product Name	Product Description
MTE4320	PS226012B00G01 / YG-28	Magnetic Switch	KCB-3A/B
MTE4321	PSMO-25G1	Magnetic Switch	
MTE4322	YX401C097-01 / YG-25 G1	Magnetic Switch	
MTE4323	YG-1A / YG-1B	Magnetic Sensor	
MTE4325	TNG-DS26E4	Magnetic Sensor	80W, 220V, 0.65A, 930r/m
MTE4326	PAD-1/PAD-2/PAD-3	Magnetic Sensor	620mm, 6 Grooves, 12mm rope
MTE4327	KCB-1	Bistable Switch	D:400, G:4/5/6, R:8
MTE4328	GKCB-III A	Bistable Switch	710*7*12/14
MTE4329	YG-30A/YG-30B	Magnetic Sensor	
MTE4330	P131028B104G01 / YTJ031-14	Door Motor	
MTE4331	YVP90-6	Door Motor	Display in Car
MTE4332	YVP71-6	Door Motor	
MTE4333		Taracation sheave	
MTE4334		Taracation sheave	
MTE4335		Traction Sheave	
MTE4336	P366701B000G02 / LHA-202A	Display Board	
MTE4337	P235710B000G02 / LHA-023A	Display Board	
MTE4339	YE602B212 / LHD-730A	Display Board	
MTE4348	LHA-025AG02 / LHH-114B	Display Board	
MTE4349	LHH-122A	Display Board	
MTE4353	LHS-200B / LHS-200C	Display Board	
MTE4355	P235705C000G01 / LHS-210A	Display Board	
MTE4356	P235706C000G01 / LHS-220A	Display Board	



Mitsubshi Elevator Parts

ELEVATOR



MTE4358



MTE4359



MTE4363



MTE4364



MTE4365



MTE4366



MTE4367



MTE4369



MTE4373



MTE4374



MTE4375



MTE4376



MTE4378



MTE4380



MTE4383



MTE4385



MTE4386



MTE4388



MTE4389



MTE4390



MTE4393



MTE4403



MTE4404



MTE4405



MTE4406



MTE4407



MTE4408



MTE4409



MTE4416



MTE4417

GNL Model	Mitsubshi OEM /Model	Product Name
MTE4358	LHS-400A	Display Board
MTE4359	LHS-410A	Display Board
MTE4363	LHS-402A	Display Board
MTE4364	LHD-601A	Display Board
MTE4365	LHD-620B	Display Board
MTE4366	LHD-650A	Display Board
MTE4367	KCR-965A	Power Supply Board
MTE4369	DOR-143A / DOR-143D / DOR-144A	Door Operate Board
MTE4373	DOR-261B	PC Board
MTE4374	DOR-275A	Door Operate Board
MTE4375	DOR-420	PC Board
MTE4376	DOR-525	PC Board
MTE4378	DOR-545A	Door Operate Board
MTE4380	DOR-111B	Door Operate Board
MTE4383	DOR-201B / DOR-101A	Door Operate Board

GNL Model	Mitsubshi OEM /Model	Product Name
MTE4385	DOR-120C	PC Board
MTE4386	DOR-1231B	PC Board
MTE4388	P203702B000G01	PC Board
MTE4389	KCA-760A	PC Board
MTE4390	PSM-011A / PSM-011B	PC BOARD
MTE4393	KCR-907A	PC Board
MTE4403	LHS-420A	PC Board
MTE4404	KCA-601A	PC Board
MTE4405	KCA-600A	PC Board
MTE4406	KCA-751A	PC Board
MTE4407	KCA-762A	Function Board
MTE4408	KCA-910A	PC Board
MTE4409	P203712B000G01	PC Board
MTE4416	KCC-100A	PC Board
MTE4417	KCC-310C	PC Board

Mitsubshi Elevator Parts



Elevator



MTE4418



MTE4419



MTE4420



MTE4421



MTE4422



MTE4423



MTE4426



MTE4428



MTE4429



MTE4430



MTE4431



MTE4434



MTE4435



MTE4436



MTE4437



MTE4438



MTE4439



MTE4440



MTE4441



MTE4442



MTE4443



MTE4444



MTE4445



MTE4446

GNL Model	Mitsubshi OEM /Model	Product Name
MTE4418	KCC-400	PC Board
MTE4419	P203701B000G03	PC Board
MTE4420	KCC-408C	PC Board
MTE4421	KCD-600E	PC Board
MTE4422	KCD-701C	PC Board
MTE4423	KCD-911A	GPS-4 Main Board
MTE4426	KCJ-100A	PC Board
MTE4428	KCJ-120B	SPVF E1 Board
MTE4429	P203722B000G01	PC Board
MTE4430	KCJ-151A	PC Board
MTE4431	KCJ-400A	GPS-1 Board
MTE4434	KCR-650A	Motion Control Board
MTE4435	KCR-759A/KCR-759B/KCR-759C	Motion Control Board
MTE4436	KCR-900B	PC Board
MTE4437	KCR-910A	Motion Control Board
MTE4438	P203704B000G04	PC Board
MTE4439	KCW-350A	PC Board
MTE4440	KCW-510B	PC Board
MTE4441	KCY-205B	PC Board
MTE4442	KCZ-411A	PC Board
MTE4443	KCZ-532A	PC Board
MTE4444	KCZ-610	PC Board
MTE4445	LIR-219A / LIR-220A	PC Board
MTE4446	LIR-223	PC Board
MTE4448	LIR-812	PC Board



Mitsubshi Elevator Parts

Elevator



MTE4448



MTE4451



MTE4452



MTE4454



MTE4455



MTE4456



MTE4457



MTE4461



MTE4462



MTE4464



MTE4465



MTE4466



MTE4468



MTE4469



MTE4471



MTE4473



MTE4475

GNL Model	Mitsubshi OEM /Model	Product Name
MTE4451	LOA-410A	PC Board
MTE4452	LOA-422	PC Board
MTE4454	LOA-503A	PC Board
MTE4455	P231701B000G01	Door Operation Board
MTE4456	P231707B000G03	Door Operation Board
MTE4457	DL2-VCO	SPVF Door Operation Board
MTE4461	P203709B000G01	Motion Control Board
MTE4462	P203703B000G02	PC Board
MTE4464	P203721B000G01	Function Board
MTE4465	P203710B000G02	Extend Board
MTE4466	P203712B000G01	PC Board
MTE4468	P203713B000G11	Interface Board
MTE4469	P235711B000G02	Main Board
MTE4471	LIR-218A	PC Board
MTE4473	KCJ-160A	PC Board
MTE4475	KCR-945A	PC Board

OTIS Elevator Parts



Elevator



OTE2001



OTE2004



OTE2006



OTE2007



OTE2008



OTE2009



OTE2011



OTE2012



OTE2013



OTE2014



OTE2015



OTE2016



OTE2017



OTE2018



OTE2019

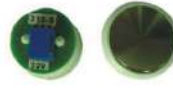

OTE2020



OTE2021



OTE2022



OTE2023



OTE2024



OTE2025



OTE2026



OTE2027



OTE2028

GNL Model	OTIS OEM /Model	Product Name	Product Description
OTE2001		GS09 Door Contact	
OTE2004	AAA717AM2	Door Belt	
OTE2006		Selector Tape	
OTE2007	GAA358GX1	Door Shoe Slider Clip	90*36*8mm
OTE2008	STS3200S8M	S8M 15mm Door Belt	
OTE2009	FAA149BK1	AT120 Door Belt Clip	
OTE2011	XAA731A1	Buzzer	OMA4351ARF 21VF
OTE2012		SCF-75TH Electric Bell	AC220V/8W
OTE2013		VCE4-75TH Electric Bell	DC12V/8W
OTE2014	TAB330AJ1	18ATF Brake Coil	
OTE2015	DAA234J1	Brake Magnet	
OTE2016	DAA330K5	DZE-14 Brake	1800N
OTE2017	DAA330K3	DZE-14 Brake	2100N
OTE2018	BR32A/B	Push Button	Dia: 27mm, DC24V-30V
OTE2019	XAA323S1C	Push Button	30V
OTE2020	BR27C	Push Button	Flat, unpolished, 27mm
OTE2021	BR27A	Push Button	BR27 Hairline
OTE2022	BR27	Push Button	BR27 Hairline, Orange housing
OTE2023	A3N47324	Push Button	
OTE2024	A3N47325	Push Button	
OTE2025	FAA25090L2	Push Button	with Center LED Light
OTE2026	BR34A	Push Button	DC24V
OTE2027	FAA25090A313	Push Button	White plastic
OTE2028	FAA25090A314	Push Button	Yellow plastic



OTIS Elevator Parts

Elevator



GNL Model	OTIS OEM /Model	Product Name	Product Description
OTE2029	DAA10204B	Push Button	Dia:32*32
OTE2030	DAA10204B	Push Button	Dia:32*32
OTE2034	AK-21	Push Button	
OTE2035	F0209191A	BS34A Push Button	
OTE2036	BR34A-B	Push Button	DC24V
OTE2038	FAA25090A711	Push Button	
OTE2050	BS34A	Push Button	
OTE2051		Push Button	
OTE2053	AAA633L1	Encoder	
OTE2054	FAA633B2	Encoder	DO2000, IG06-0986 / ABX-500-PP
OTE2055	FAA633B1	LIKA Door Encoder	C50-Y-500BNF29-S533A
OTE2056	AAA633AJ1/AAA633AJ401	Encoder	TAA27076ADY1
OTE2057	AAA633Z1	Encoder	ERN 461 3600ppr 56S15-4G
OTE2058	DAA25140NNN14	COP Display	Single 8 Display
OTE2059	DAA26800AL1/ DAA25005C1	RS14 COP Address Board	Different version Available
OTE2061	GBA24350BH1	Control Box	
OTE2062	GBA24350AW11	Control Box	
OTE2063	GHA24350BD11	DCSS V E Door Controller	
OTE2064	GFA24350AW1	DCSS IV Door Controller	
OTE2065	GCA24353G1	Door Controller	DCSS V
OTE2066	F-FBA24350F	AC Door Motor	
OTE2069		Car Door Hanger	
OTE2070		Landing Door Hanger	
OTE2071	ADB23750AAA	Large LCD Screen	
OTE2072	JOB6840BA1	Double 8 Display	
OTE2073	XAA23550B4	Double 8 Display Board	
OTE2074	XAA23550B3	Single 8 Display Board	
OTE2075	F-FBA23600V1	Display Board	

OTIS Elevator Parts



Elevator



GNL Model	OTIS OEM /Model	Product Name	Product Description
OTE2076	LP 10120141055	43 inch TFT LCD Display Board	
OTE2078	XAA25140AAB201	21VF COP Single 8 Display	
OTE2079	XAA25140AAB202	21VF COP Double 8 Display	
OTE2080	JAA25140AAC126	Double Figure Landing Display	
OTE2081	JAA25140AAD102	Single Figure Landing Display	
OTE2084	DAA26800G1	Display Board	
OTE2085	XAA25140AAD002	21VF LOP Single 8 Display	
OTE2086	XAA25140AB1	COP Single 8 DISPLAY(3-in-1)	
OTE2087	XAA25140AB2	COP Double 8 DISPLAY(3-in-1)	
OTE2090	F-FBA23600V1	Blue LCD Display	
OTE2091	FAA24350BL2	KAG AT120 Motor Links	
OTE2092	XAA20500H1	Door Motor	XRDS-80J1, 80W, DC110V/11A
OTE2093	YVP90-6B1	DO2000 VVVF Door Motor	
OTE2094	XAA712AY3	Larding Door Steel Wire Rope M=900 MMs	
OTE2096		Door Slider	80/50*35*12,Canvas
OTE2097		Door Slider	80/50*35*12,Plastic
OTE2098		Door Slider	
OTE2099		Door Slider	70*12
OTE2100		Guide Shoe	200*40*76*13
OTE2101		Door Slider	
OTE2102	FAA24350BM1	AT120 DOOR TRANSFORMER	230V, cable length=25m
OTE2103	FAA24350BM2	AT120 DOOR TRANSFORMER	400V, cable length=5m
OTE2104	FAA24350BM3	AT120 DOOR TRANSFORMER	230V, cable length=5m
OTE2105		Door Vane	
OTE2106		Door Vane Roller	30*8 ID:6 g-M8
OTE2107		Door Vane Roller	37*20 ID:12



OTIS Elevator Parts

ELEVATOR



OTE2108



OTE2109



OTE2110



OTE2115



OTE2116



OTE2117



OTE2118



OTE2119



OTE2120



OTE2121



OTE2122



OTE2123



OTE2124



OTE2125



OTE2126



OTE2127



OTE2128



OTE2129



OTE2130



OTE2133



OTE2134



OTE2135



OTE2136



OTE2137



OTE2138



OTE2140



OTE2141



OTE2142



OTE2143



OTE2144

GNL Model	OTIS OEM /Model	Product Name	Product Description
OTE2108	Door Vane		
OTE2109	3100 Door Vane		
OTE2110	3100 Door Vane		
OTE2115	Silicon Controller	PDT 6016C 3J	
OTE2116	Silicon Controller	PDT 6016C 3I	
OTE2117	BRA Fan		
OTE2118	BRB Round fan		
OTE2119	508 GUIDE RAIL		
OTE2120	Returning section of guide rail		
OTE2121	Main Rail (Car) Guide Shoe	DY06261Y	Groove:150*48
OTE2122	Counterweight Guide Shoe	DY06261Y	Groove:150*48
OTE2123	Roller for Guide Shoe		114*36 6203
OTE2124	Roller for Guide Shoe		160*30 6203 ID:17
OTE2125	Roller for Guide Shoe		114*36 6202 with Shaft
OTE2126	Roller for Guide Shoe		76*215 6203
OTE2127	Guide Shoe Insert		98*32*10
OTE2128	Triad Guide Shoe Insert		200*25*6 black
OTE2129	Triad Guide Shoe Insert		200*30*6
OTE2130	Triad Guide Shoe Insert		one 215*42*4, Two 203*47*4
OTE2133	Guide Shoe Insert		200*20*6 Black
OTE2134	Guide Shoe Insert	FAA380F4	150*20*6
OTE2135	Guide Shoe Insert		99-22-8mm
OTE2136	Guide Shoe Insert		100-25-30-16mm
OTE2137	Guide Shoe Insert		100-30-28, 10mm
OTE2138	Guide Shoe Insert		100-30-28, 16mm
OTE2140	Guide Shoe Insert		150-35-16mm
OTE2141	Guide Shoe Insert		150-35-10mm, Iron Back
OTE2142	Guide Shoe Insert		
OTE2143	Guide Shoe Insert		200-35-6mm
OTE2144	Guide Shoe Insert		200-35-16mm

OTIS Elevator Parts



Elevator



OTE2145



OTE2146



OTE2147



OTE2148



OTE2149



OTE2150



OTE2151



OTE2152



OTE2153



OTE2154



OTE2155



OTE2156



OTE2157



OTE2158



OTE2159



OTE2162



OTE2162



OTE2163



OTE2164



OTE2165



OTE2166



OTE2167



OTE2168



OTE2169



OTE2170



OTE2171



OTE2172

GNL Model	OTIS OEM /Model	Product Name	Product Description
OTE2145	KAA24180A	Roller Guide - Car	125mm Diameter
OTE2146	KAA456K1	Roller for Guide - Car	125mm Diameter
OTE2147	456CN	Roller for Roller Guide Shoe	OD: 95mm
OTE2148		Cushion for Guide Shoe Insert	148*32*10
OTE2149		Guide Shoe Insert	145*35*6
OTE2150		Guide Shoe Insert	200*25*6 white
OTE2151		Guide Shoe Insert	
OTE2152		LOP Cover	
OTE2153		LOP Cover	
OTE2154		Hanger Roller	φ86*20 6204 ID:20
OTE2155		Hanger Roller	70*20
OTE2156		Hanger Roller	90*18 6203
OTE2157		Hanger Roller	
OTE2158		The Roller Of Door Hangs φ 84	
OTE2159		3100II Hanger Roller	56mm
OTE2162		HANGER ROLLER For OTIS/XIZI OTIS	74*13 6203-screw
OTE2163		Hanger Roller	48*14*6200, M10
OTE2164		Block Terminal	
OTE2165		Block Terminal	
OTE2166		Block Terminal	
OTE2167	XBA23550B1	Twins Display	
OTE2168	XAA25302M2	Intercom for security room	
OTE2169	ADA21290A	OVF30 - 90amp Inverter	
OTE2170	ACA21290BM1	OVF DRIVE, 210 amp, 480V	
OTE2171	GCA21150D1	Inverter OVF20CRC 9kw	
OTE2172	XAA24591D1	CEDES Light Curtain	



OTIS Elevator Parts

Elevator



OTE2173



OTE2174



OTE2175



OTE2176



OTE2178



OTE2180



OTE2181



OTE2183



OTE2184



OTE2186



OTE2189



OTE2190



OTE2282



OTE2283



OTE2284



OTE2285



OTE2286



OTE2287



OTE2289



OTE2288



OTE2290



OTE2291



OTE2292



OTE2293



OTE2294



OTE2295

GNL Model	OTIS OEM /Model	Product Name	Product Description
OTE2173	XAA431Z1	COP Electric Switch Lock DS-4	
OTE2174		GS09 Door Lock Wheel	
OTE2175		Door Lock	37*20 ID:12
OTE2176	GS09(PB47)	Door Lock	
OTE2178		3100 Door Lock	
OTE2180	XAA431AB2	Triangle Lock Left/Right	
OTE2181	XAA431AB1	Triangle Key	
OTE2183		PB123 Side Contact Door Lock For OTIS/XIZI OTIS	
OTE2184		Door Lock Mandril	
OTE2186		Door Lock Roller	
OTE2189	XAA349C1	Oil Can Square	52*20 6201 ID:12
OTE2190	XAA349C2	Oil Can Circle	
OTE2282		Pit Inspection Box	
OTE2283		Pit Inspection Box	
OTE2284		Car Top Inspection Box	
OTE2285		Light for Car Top Inspection Box	For GEN 2
OTE2286		Pit Inspection Box	For GEN 2
OTE2287		Pit Inspection Box	
OTE2288		Pit Inspection Box(Old Version)	
OTE2289		Pit Inspection Box(New Version)	
OTE2290		Metal Overhaul Plug	
OTE2291		Overhaul Plug	
OTE2292	XAA621Z1	HLP-24M Power Supply	
OTE2293	XAA613S3	Relay MY4 AC220V	
OTE2294	XAA638S4	Contactor SC-4-1	
OTE2295		IRC Relay	

OTIS Elevator Parts



Elevator



OTE2296



OTE2298



OTE2299



OTE2300



OTE2301



OTE2302



OTE2303



OTE2304



OTE2307

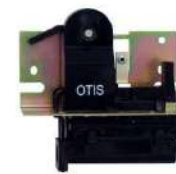

OTE2308



OTE2310



OTE2311



OTE2312



OTE2313



OTE2314



OTE2315



OTE2316



OTE2317



OTE2318



OTE2319



OTE2320



OTE2321



OTE2322

GNL Model	OTIS OEM /Model	Product Name	Product Description
OTE2296		Aluminum Double-Groove Sill	74*21*2180
OTE2298	XAA177AZ4	Photo Sensor	
OTE2299	SSGD-1L(NC)	Photo Sensor	
OTE2300	MPS-1600-OTIS	Photo Sensor MPS-1600-OTIS	
OTE2301	XBA24590G2	OMRON E3JK-5 Photo Electric Switch	
OTE2302	DAA429F, SSGD-1H(NO)	Photo Sensor	
OTE2303	GAA621BV1	Transformer	
OTE2304	GAA22439E2, GAA22439E12	Selector Tape Sensor Left & Right	
OTE2307	XAA177BL1, XAA177BL3, XAA177BL4	Switch Center, Right & left	
OTE2308		Limite Switch	
OTE2310		SDK 716-1 Combined Switch	
OTE2311		SDK 716-2 Combined Switch	
OTE2312		SDK 716-3 Combined Switch	
OTE2313		SDK 716-3 Combined Switch	
OTE2314	A6098B15	Mechanical Switch	
OTE2315		SDK-740 40A Host Command Switch	
OTE2316	XAA177CB1	GS09 Landing Door Switch Conatct	
OTE2317	6098D1	Mechanical Switch	
OTE2318	6098D3	Mechanical Switch	
OTE2319	TAA177AH1	Switch Left	
OTE2320	TAA177AH2	Switch Right	
OTE2321		Contacts	
OTE2322	DAA629F2	Inductor Switch	Red DC 10V-30V



OTIS Elevator Parts

Elevator



OTE2323



OTE2324



OTE2325



OTE2326



OTE2327



OTE2328



OTE2329



OTE2331



OTE2332



OTE2333



OTE2335



OTE2336



OTE2337



OTE2339



OTE2340



OTE2341



OTE2342



OTE2343



OTE2346



OTE2347



OTE2348

GNL Model	OTIS OEM /Model	Product Name	Product Description
OTE2323	DAA629F3	Inductor Switch	Red DC 10V-30V
OTE2324	A6098B3	Mechanical Switch	
OTE2325		Switch	Ni75U-CP80-VP4X2
OTE2326	XAA177A1	Limit Switch	(D4N-4132,1NC/1NO) (TR236-11z)
OTE2327		Limit Switch	TS236-11z, 1NC/1NO
OTE2328	A6098B7	Mechanical Switch	
OTE2329	XAA177AP1	Switch LX29	
OTE2331	XAA177BV2	Switch Z-15GQ22-B	
OTE2332	FAA21700F1	ABA21700X3 Traction Belt Detection Device	
OTE2333	FAA21700F2	ABA21700X2 Traction Belt Detection Device	
OTE2335	DAA20220D6	TRACATION WHEEL 480*6*12	
OTE2336		Oil Seal	
OTE2337	OTIS-TOEC40	TOEC40 TRACTION WHEEL	570*3/4/5*13
OTE2339	XAA225AJ1	Transformer AT25	
OTE2340	XAA225P1	Transformer TDE-101(36V)	
OTE2341	XAA225R1	Transformer TDE-521	
OTE2342	XAA225AG3	Transformer ACVV380/220V	
OTE2343	GAA21750S1	Servise Tool/Test Tool	Can not read GECB information, unlimited use, Black Color
OTE2346	GAA2150AK4	Servise Tool/Test Tool	Can read & change GECB information, unlimited use, Blue Color
OTE2347	GAA2150AK	Servise Tool/Test Tool	SM-01-F 3100R2 Type, Light Black Color
OTE2348		Sheave	

OTIS Elevator Parts



Elevator



OTE2192



OTE2193



OTE2194



OTE2195



OTE2196



OTE2197



OTE2199



OTE2200



OTE2201



OTE2202



OTE2203

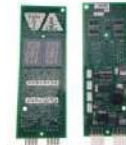

OTE2205



OTE2207



OTE2208



OTE2209



OTE2210



OTE2211



OTE2212

GNL Model	OTIS OEM /Model	Product Name	Product Description
OTE2192	GFA21240D10	LCB-II PC Board	For OTIS 90
OTE2193	JFA26801AAF002	LMCSS-MCB PC Board	KAA26800ABB6 + AEA26800AML2
OTE2194	KAA26800ABB6	PC Board	
OTE2195	BRDS	BRDS Door operator PC Board	
OTE2196	LPB2	LPB-II PC Board	
OTE2197	GAA26800AL1	SOM-II PC Board	
OTE2199	GEA23550D1	RS-5 PC Board	
OTE2200	GCA26800KA10	TCBC Board	
OTE2201	GDA21240D	Motion Control Board	
OTE2202	GDA26800KA1-61	PC Board	
OTE2203	GBA25005	RS18 PC Board	
OTE2205	DAA26800G2	PC Board	
OTE2207	JO6840JV5	Power Supply Board	
OTE2208	GEA21270A1	RCB-II PC Board	
OTE2209	B9693AE1	RSEB PC Board	
OTE2210	JGA26801AAF	NIPPON PC Board	
OTE2211	GEA26800AL	SOM-II PC Board	
OTE2212	GAA26800KM1	SPBC-II Inspection PC Board	



OTIS Elevator Parts

ELEVATOR



OTE2213



OTE2214



OTE2215



OTE2216



OTE2217



OTE2218



OTE2219

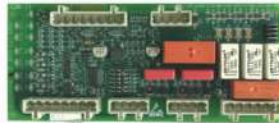

OTE2221



OTE2222



OTE2223



OTE2224



OTE2225



OTE2226



OTE2227



OTE2229



OTE2230



OTE2231



OTE2232



OTE2233



OTE2234



OTE2235

GNL Model	OTIS OEM /Model	Product Name	Product Description
OTE2213	GDA26800KA2	TCBC PC Board	
OTE2214	ACA26800AKT1	GDCB PC Board	
OTE2215	GBA26803B1	RSFF PC Board	
OTE2216	ADA26800MB1	OVF-30 Drive PC Board	
OTE2217	GCA26800KF2	MCB-III PC Board	
OTE2218	ABA26800ABL	E411 ASSY PC Board	
OTE2219	A9693C4 RS4	RS4 PC Board	
OTE2221	GCA26800AL2	SOM-II PC Board	
OTE2222	JCA26807BAN306	PIB-II PC Board	
OTE2223	GAA26800KB1	SPBC-III PC BOARD	
OTE2224	A9693D2	G SERIAL G01 PC Board	
OTE2225	JAA26805AAA001	DISS PC Board	
OTE2226	AGA26800UD2	OVF-30 PC Board	
OTE2227	ADA26800AML2	GECB PC Board	
OTE2229	ABA26800XU1	OVF-30 PC Board	
OTE2230	GAA26800KN1	OVF-20CR PC Board	
OTE2231	GAA26810C1	WWPB-2 PC Board	
OTE2232	GBA26800J5	PDB-I PC Board	
OTE2233	GAA26810A2	WWPDB PC Board	
OTE2234	GCA26800H2	MCB-II PC Board	
OTE2235	GCA26800KG4	PC Board	

OTIS Elevator Parts



Elevator



OTE2236



OTE2237



OTE2238



OTE2239



OTE2240



OTE2242

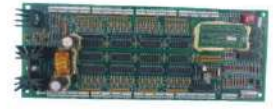

OTE2244



OTE2246



OTE2247



OTE2248



OTE2249



OTE2250



OTE2251



OTE2252



OTE2253



OTE2254



OTE2255



OTE2256



OTE2257



OTE2258



OTE2259



OTE2260



OTE2261



OTE2262

GNL Model	OTIS OEM /Model	Product Name	Product Description
OTE2236	GCA26800H1	MCB-II PC Board	
OTE2237	GBA26800J1	PC Board	
OTE2238	ABA26800XU2	PC Board	
OTE2239	ACA26800VA_VB	PC Board	
OTE2240	JAA26801AAH005	PC Board	
OTE2242	GBA21230F2	LB-II PC Board	
OTE2244	ADA26800TH1	PC Board	
OTE2246	AMCB2	LWB-IIAMCB2 PC Board	
OTE2247	DAA26800J	PC Board	
OTE2248	FAA25402AB1	PC Board	
OTE2249	GAA26800KS1	PC Board	
OTE2250	JFA26801	LMCSS-MCB PC Board	
OTE2251	GBA25005D1	HBB PC Board	
OTE2252	GAA26800KP1	PC Board	
OTE2253	JCA26801AAJ001	RCP-I PC Board	
OTE2254	JO6840KE-14	PC Board	
OTE2255	JO6840KE-15	PC Board	
OTE2256	JO6840PM3	PC Board	
OTE2257	FAA25000E	PC Board	
OTE2258	NAA20412AAA0	PC Board	
OTE2259	OMA4351AEN	RS5-3 PC Board	
OTE2260	DAA25005A1	RS14-3 PC Board	
OTE2261	GHA21270A1	RCB-II PC Board	
OTE2262	B9693C2	RS-3 PC Board	



OTIS Elevator Parts

Elevator



OTE2263



OTE2265



OTE2266



OTE2267



OTE2268



OTE2269



OTE2270



OTE2271



OTE2272



OTE2273



OTE2274



OTE2275



OTE2276



OTE2277



OTE2278



OTE2279



OTE2280



OTE2281

GNL Model	OTIS OEM /Model	Product Name	Product Description
OTE2263	SOM-A9693F1	SOM-A9693F1 PC Board	
OTE2265	NBA20401AAA00	ACB-II PC Board	
OTE2266	GBA26800KJ1	LWB-II PC Board	
OTE2267	GEA26800BA2	TCB PC Board	
OTE2268	FAA24350BK1	Door Controller (GERMANY)	Made in Germany
OTE2269	ACA26800HJ1	Display Board	
OTE2270	GCA26800KV7	PC Board	
OTE2271	GOA9687AM2	LVCT Capacitor Board	
OTE2272	LMCB	LMCB Main Board	Version: V20/V30/V31/V32/V40/V41
OTE2273	DBA26800J1	RS32 PC Board	
OTE2274	CPM2B-60CDR-D-CH	XIZI 508 Main Board XBA26201Y	
OTE2275	GAA26800LC3	GECB PC Board	
OTE2276	GBA26800KX1	SPBC-III PC BOARD	
OTE2277	9693J1, 9693J2	PC Board 9693J1/9693J2	
OTE2278	B9693MG1	ADISS/DISS PC Board GAA30154CAA1	
OTE2279	ABA26800GN1	Display PC Board	
OTE2280	OMA4351AJH	Push button Board	
OTE2281	AST014	PG Card	

Schindler Elevator Parts



ELEVATOR



SHE13001



SHE13002



SHE13003



SHE13004



SHE13005



SHE13006



SHE13007



SHE13008



SHE13009



SHE13012



SHE13013



SHE13016



SHE13017



SHE13024



SHE13025



SHE13027



SHE13028



SHE13029



SHE13031



SHE13035



SHE13036



SHE13038



SHE13039



SHE13041



SHE13042

GNL Model	Schindler OEM /Model	Product Name	Product Description
SHE13001	D4-CL	Push Button	
SHE13002	DDSQ1.QA	Push Button	
SHE13003		GPS Lock	
SHE13004		Push Button	
SHE13005		Push Button	
SHE13006		Push Button	
SHE13007		Push Button	
SHE13008		GPS Lock 300/500	
SHE13009		COP LED Light	
SHE13012	ID.NR.181369	Breaker	
SHE13013		Door Buffer	
SHE13016		Door Hanger	800/900/1000
SHE13017		Door Hanger	800/900
SHE13024	ID.NR.Z134148 / PB260	QKS9 Door Lock Set	Left & Right
SHE13025		Door Lock Roller	31*21 ID:14
SHE13027	AD9MS	Door Lock	
SHE13028	PB16D	Door Lock Contact	
SHE13029	PB237	Triangle Lock	
SHE13031	QKS9	Door Lock Contact	
SHE13035	AZ-061	Door Lock Contact	
SHE13036	ID.NR.291286	BISTABLE Switch	
SHE13038	PB16D	Door Lock	
SHE13039		V30 Door Lock	
SHE13041	AD10MS	Door Lock	
SHE13042	PB16D	Door Lock Roller	40x28



Schindler Elevator Parts

Elevator



GNL Model	Schindler OEM /Model	Product Name	Product Description
SHE13043	ID.NR.147845	MQKS9-6/12U Type Door Motor	
SHE13046		Door Wire Rope	
SHE13050		Door Slider	
SHE13052	300P V30 5400	Door Slider	21/25*18*10/11
SHE13053		Door Slider	80x60x13
SHE13054		Door Slider	12/15x74
SHE13056		Door Slider	
SHE13057	ID.NR.59300010CL / 59300018CL	V30 Door Vane Set	
SHE13058	ID.NR.59313572	3300 Door Vane Set	
SHE13059	ID.NR.250711	QKS9 Door Vane Set	
SHE13060	ID.NR.317945-13	Heidenhain Encoder	ECN 413 2048 16S15-2K
SHE13063		QKS9 Magnetic Drum	
SHE13066	EBI169643	300P Magnetic Drum	
SHE13068	ID.NR.142984	RV140 Fan	
SHE13069	FB-1042B	Double Speed Fan	
SHE13070	VF-140	Ventilator Fan	
SHE13071		B22 Guide Shoe Insert	220*16/10mm
SHE13072		CW Guide Shoe insert	150*30 10/16mm
SHE13073		300P CW Guide Shoe	
SHE13074		300P Guide Shoe insert	101*10/16mm
SHE13077		Guide Shoe insert	220*30 10mm
SHE13078		Guide Shoe insert	140*10/16MM
SHE13079		3600AP Guide Shoe	
SHE13080		300P Guide Shoe	65*36*16/10MM
SHE13082		Counter Weight Guide Shoe	
SHE13083		Counter Weight Guide Shoe	
SHE13084		Roller for Guide Shoe	150*30 6201 ID:12
SHE13085		R3 Roller for Guide Shoe	100*25 6205 ID:25
SHE13087		Guide Shoe	10/16MM

Schindler Elevator Parts



Elevator

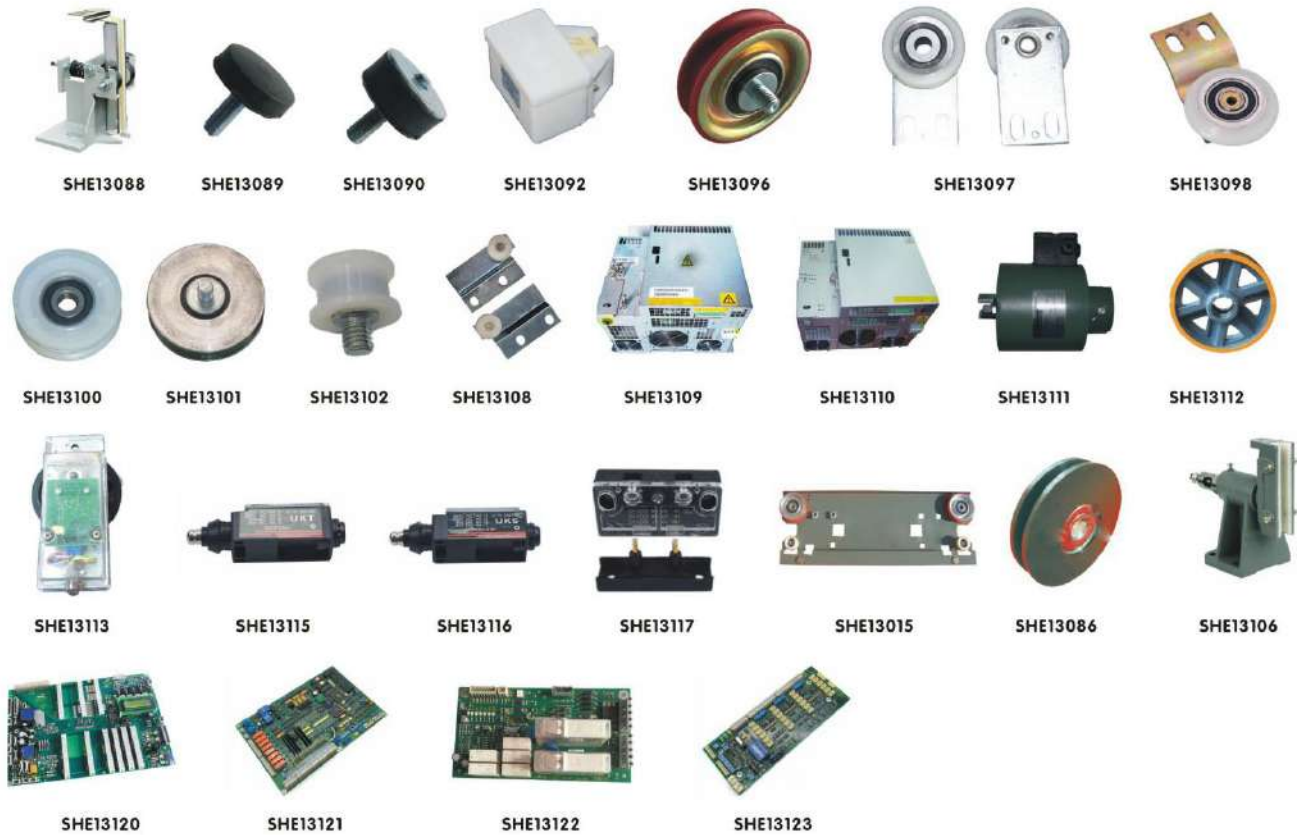

GNL Model	Schindler OEM /Model	Product Name	Product Description
SHE13088		DX-1B Car Guide Shoe	
SHE13089		Guide Shoe Rubber Cusion (rear)	40*15 M10
SHE13090		Guide Shoe Rubber Cusion (side)	40*18 M10
SHE13092		Oil Can	
SHE13096		V30 Hanger Roller	74*19 6203
SHE13097		Hanger Roller	
SHE13098		Hanger Roller	
SHE13100		QKS11 Hanger Roller	54*18MM 6200
SHE13101		AD9 Hanger Roller	72*15MM
SHE13102		V30 Hnager Roller	34*19 M12 608Z
SHE13108		QKS9 Hanger Set	
SHE13109		VF33BR Drive Inverter	
SHE13110		VF22BR Drive Inverter	
SHE13111		Brake Coil	Type: 11E/13E/14E/16E
SHE13112		Traction Sheave	
SHE13113		Door Motor Control Sensor	
SHE13115		UKT Limit Switch	Automatic Reset
SHE13116		UKS Limit Switch	
SHE13117		Landing Door Switch	50*25MM
SHE13015		Door Hanger	300P Type
SHE13086		T15 Guide Shoe	10/16MM
SHE13106		Rope Roller	60*11 6200 ID:10
SHE13120	ID.NR.590867	PC Board	ASIALOG 3.0
SHE13121	ID.NR.590713	PC Board	IVXVF 168.Q
SHE13122	ID.NR.591840	PC Board	BCM420 1.Q
SHE13123	ID.NR.590737	PC Board	PIOC 124.Q



Schindler Elevator Parts

ELEVATOR



SHE13124



SHE13125



SHE13126



SHE13127



SHE13128



SHE13129



SHE13133



SHE13134



SHE13135



SHE13136



SHE13137



SHE13138



SHE13139



SHE13140



SHE13142



SHE13146



SHE13147



SHE13148



SHE13149



SHE13150



SHE13152



SHE13153



SHE13155



SHE13156



SHE13158



SHE13159

GNL Model	Schindler OEM /Model	Product Name	Product Description
SHE13124	ID.NR.590840	PC Board	
SHE13125	ID.NR.336564	PC Board	RB98A153 V30
SHE13126	ID.NR.590880	PC Board	
SHE13127	ID.NR.590881	PC Board	
SHE13128	ID.NR.431078	PC Board	
SHE13129	ID.NR.53100249	PC Board	
SHE13133	ID.NR.591442	PC Board	
SHE13134	ID.NR.590865	PC Board	
SHE13135	ID.NR.590873	PC Board	
SHE13136	ID.NR.590863	PC Board	
SHE13137	ID.NR.590866	PC Board	
SHE13138	ID.NR.590868	PC Board	
SHE13139	ID.NR.590864	PC Board	
SHE13140	ID.NR.590869	PC Board	
SHE13142	ID.NR.591640	PC Board	
SHE13146	ID.NR.590769	PC Board	
SHE13147	ID.NR.591786	PC Board	
SHE13148	ID.NR.590780	PC Board	
SHE13149	ID.NR.591710	PC Board	
SHE13150	ID.NR.591712	PC Board	
SHE13152	ID.NR.182002	PC Board	
SHE13153	ID.NR.590871	PC Board	
SHE13155	ID.NR.590862	PC Board	
SHE13156	ID.NR.591885	PC Board	
SHE13158	ID.NR.590872	PC Board	
SHE13159	ID.NR.591572	PC Board	



TYE8001



TYE8002



TYE8003



TYE8004



TYE8005



TYE8006



TYE8007



TYE8008



TYE8009



TYE8010



TYE8011

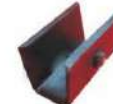

TYE8012



TYE8013



TYE8014



TYE8015



TYE8016



TYE8017



TYE8018



TYE8019



TYE8020



TYE8021



TYE8023



TYE8024



TYE8025



TYE8026



TYE8028

GNL Model	ThyssenKrupp OEM /Model	Product Name	Product Description
TYE8001	MTD182	Push Button	
TYE8002	MTD275	Push Button	41.5*37*29
TYE8003		Door Lock Wheel	33*33*20
TYE8004	K200	Door Lock	33*10
TYE8005		Triangle Lock	
TYE8006		Door Slider	
TYE8007		Door Slider	35*92*13
TYE8008	EC100RP38-L5TR-4096	Encoder	36*40*14
TYE8009	BSM150GB120DN2	IGBT	
TYE8010	SF-PCD-4E-02	Encoder	
TYE8011		Guide Shoe Roller	
TYE8012		Guide Shoe Insert	153*32*2 6204 ID:20
TYE8013		Guide Shoe Insert	48*28*17
TYE8014		Guide Shoe Insert	150*10/16
TYE8015		Guide Shoe Insert	130*10/16
TYE8016		Guide Shoe Insert	140*10/16
TYE8017	M2Z(T)S8	Door Lock	125*10/16
TYE8018		Roller Guide Shoe	
TYE8019	RFT12-F	Pit Inspection Box	Roller 153*32*2-6204
TYE8020		Oil Can	
TYE8021		Roller for Door Hanger	142*42*126
TYE8023		Door Vane	70*17 6200ID:10 GD:62
TYE8024	JF-36X	Car Intercom	
TYE8025	MS2 VOLL 6510053680	PC Board	
TYE8026	MF4 6510066680	PC Board	Nr. RB-95 A223
TYE8028	MB2/MB2.2	PC Board	MF4981201



ThyssenKrupp Elevator

Elevator



TYE8030



TYE8031



TYE8032



TYE8033



TYE8034



TYE8035



TYE8036



TYE8037



TYE8038



TYE8039



TYE8040



TYE8041



TYE8042



TYE8043



TYE8044



TYE8045



TYE8046



TYE8047



TYE8048



TYE8049



TYE8050



TYE8051



TYE8052



TYE8053



TYE8054



TYE8055



TYE8056



TYE8057



TYE8058



TYE8059

GNL Model	ThyssenKrupp OEM /Model	Product Name	Product Description
TYE8030	LMS1 6634071660	PC Board	G-141E/G-141F
TYE8031	MA9	Display	
TYE8032	MA1.XT1	Display	MA9-S/MA9-E 1.1/V2.0/V3
TYE8033	SM-04	Display	
TYE8034	MZ1000320L1	PC Board	
TYE8035	MS2060714	PC Board	MZ1
TYE8036	MF3-S	PC Board	MS2
TYE8037	MC2	PC Board	
TYE8038	CPUA-2E	PC Board	
TYE8039	CPIK48M1	Inverter	
TYE8040	1251R7 SIEI-AREG	F9 Door Motor	
TYE8041	ECW-Z1000	Load Weighing Device	
TYE8042	PJ559/PJ560	Belt	
TYE8043	BUP-30S	Leveling Sensor	
TYE8044	Nr. 103989	CEDES GLS TK Sensor	
TYE8045	E1018/E1118/E1218	Light Curtain	
TYE8046	SRS60-HAA0-K01	Encoder	1218-TKC
TYE8047	KEP-222-04	Emergency System Power Supply Device	
TYE8048	EMBP-220	Brake Controller	
TYE8049	TK-EP220/12H	Power Supply	
TYE8050	DIC-SI20P4	Door Motor Inverter	
TYE8051	CPIC-I-34	Inverter	
TYE8052	BK-01	Break Controller	
TYE8053	EK-HDJD	Weight Sensor	
TYE8054	TSR-DMS	Speed Monitor Relay	
TYE8055	LW39-16B	Inspection Switch	
TYE8056	BN325-R	Megnet Switch	
TYE8057	BG101-S20P2S	Door Inverter	
TYE8058	TCM MC2	Service Tool/Test Tool	
TYE8059	PDA-HP	Service Tool/Test Tool	API/CPI

LG SIGMA Elevator Parts



Elevator



GNL Model	LG SIGMA OEM /Model	Product Name
LS11001	A4J10136	Alarm Button
LS11004		MTD260 Push Button
LS11006		Push Button
LS11007	YEU720N03A	Alarm Button
LS11008		KA141 Push Button
LS11009		MTD165 Push Button
LS11012	YEU720N09B	AK29B Push Button
LS11013		KA143 Push Button
LS11014		KA142 Push Button
LS11018		PB1400 Car Door Lock
LS11024	MH-100-1024BO	Door Vane
LS11025	PKT1040-1024-C15C	Rotary Encoder
LS11026	PKT5006-512-G12C	Rotary Encoder
LS11027	3X02767-B1	Rotary Encoder
LS11028	SMD-35P	DPD-05 Communication Board
LS11029	GMD-40	Contactora
LS11032	SMD-20P	Contactora
LS11033		Contactora

GNL Model	LG SIGMA OEM /Model	Product Name
LS11038		8K Triad Guide Shoe Insert Size: 120*22*7 or 120*20*6
LS11039		13K Triad Guide Shoe Insert Size: 120*27.5*7 or 120*25*6
LS11041		LG Roller Guide Shoe
LS11045		EL-1375 Over Speed Governor Limit Switch
LS11047		Hanger Roller Size: 68*14 6202 GD:60 ID:15
LS11048		Hanger Roller Size: 33*10 6g-M10
LS11057	MPS-1600	Proximity Sensor
LS11058	PSMO-25G2-LG	Proximity Sensor
LS11060	9722F	GVT-1000 Sensor
LS11061		KN-510R Sensor
LS11062		SB-51CT Sensor
LS11069	DOA-100	Tractive Wheel Size: 605*12*4/5
LS11070	OPP-4000	Service Tool/Test Tool
LS11071	OPP-2000	Service Tool/Test Tool
LS11072		Service Tool/Test Tool



LG SIGMA Elevator Parts

Elevator

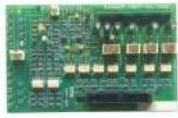

LS11084



LS11087



LS11088



LS11089



LS11090



LS11091



LS11092



LS11093



LS11094



LS11095



LS11096



LS11097



LS11098



LS11100



LS11101



LS11102

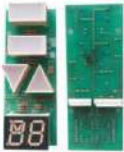

LS11103



LS11105



LS11106



LS11107



LS11108



LS11109

GNL Model	LG SIGMA OEM /Model	Product Name
LS11084	DPP-150	Communication PC Board
LS11087	IPM-RLA	PC Board
LS11088	DOC-132	PC Board
LS11089	DHI-430N	Display Board
LS11090	DPP-200	PC Board
LS11091	DHL-250	PC Board
LS11092	EISEG-107	Display Board
LS11093	IR02661	Display Board
LS11094	1R02483-A0	Display Board
LS11095	INV-MPU-2	Main PC Board
LS11096	DCD-31M	Door Operator PC Board
LS11097	DHI-221N	Display
LS11098	DHF-121	Circuit PC Board
LS11100	DOP-111	Power PC Board
LS11101	EISEG-212	Display
LS11102	DOP-310	Power PC Board
LS11103	PHI-500B	Display
LS11105	CJB-100	Car Top PC Board
LS11106	1R02493	COMM PC Board
LS11107	CSB-EB	Car Communication PC Board
LS11108	DCD-201	Door Operate PC Board
LS11109	DCD-221	Door Operate PC Board

LG SIGMA Elevator Parts



Elevator



LS11110



LS11111



LS11112



LS11114



LS11115



LS11117



LS11119



LS11120



LS11122



LS11123



LS11124



LS11125



LS11126



LS11127



LS11131



LS11132



LS11133



LS11134



LS11135



LS11136



LS11138



LS11139



LS11140



LS11141



LS11142



LS11143



LS11144



LS11145



LS11146



LS11147



LS11158



LS11160



LS11161

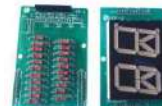

LS11174

GNL Model	LG SIGMA OEM /Model	Product Name
LS11110	DCD-230	Door Operate PC Board
LS11111	DCI-242	PC Board
LS11112	DCI-243	PC Board
LS11114	DCL-240	PC Board
LS11115	DCL-244	PC Board
LS11117	DHF-100	PC Board
LS11119	DHG-160	PC Board
LS11120	DHG-161	PC Board
LS11122	DHL-270	Communication PC Board
LS11123	DOC-100	PC Board
LS11124	DOC-101	PC Board
LS11125	DOC-103	PC Board
LS11126	DOC-120	PC Board
LS11127	DOC-130	PC Board
LS11131	DOM-110A	Communication PC Board
LS11132	DOM-130A	Communication PC Board
LS11133	DOP-100	PC Board

GNL Model	LG SIGMA OEM /Model	Product Name
LS11134	DOP-130	Power PC Board
LS11135	DOP-300	PC Board
LS11136	DOR-230	PC Board
LS11138	DPC-100	PC Board
LS11139	DPC-120	PC Board
LS11140	DPC-121	Motion Control PC Board
LS11141	DPC-130	Motion Control PC Board
LS11142	DPP-100	PC Board
LS11143	DPP-101	PC Board
LS11144	DPP-131	PC Board
LS11145	MCB-2001Ci	PC Board
LS11146	EISEG-205	LOP Display
LS11147	EISEG-221	LOP Display
LS11158	OPB-100	PC Board
LS11160	SMCB-3000Ci	PC Board
LS11161	WTCT5911	PC Board
LS11174	HDF-1 HDF-2	Display



LG SIGMA Elevator Parts

Elevator



GNL Model	LG SIGMA OEM /Model	Product Name
LS11176	DCI-230	Display
LS11177	DHI-201	LOP Display
LS11178	2R24168	LOP Display
LS11180	SEMR-100	PC Board
LS11181	EISEG-260	Display
LS11182	POC-300	Main Board
LS11184	DHI-201N	Display
LS11185	DOR-131	PC Board
LS11186	DHG-162	PC Board
LS11188	DOC-220	PC Board
LS11189	DCL-243	PC Board
LS11191	DCI-210N	Display
LS11192	DCI-260	Display
LS11193	DCL-200	PC Board
LS11195	DPC-123	PC Board

GNL Model	LG SIGMA OEM /Model	Product Name
LS11197	EISEG-207	Display
LS11201	EISEG-208	Display
LS11203	DHP-100	Communication PC Board
LS11204	EOC-300	PC Board
LS11205	DPB-100A	PC Board
LS11208	DOL-210	PC Board
LS11211	CONN	Connector PC Board
LS11212	DOR-232	PC Board
LS11213	EISEG-108	Display
LS11214	DOP-112	Power PC Board
LS11216	EOC-200	Main Board
LS11217	OPB-2000SPA	Communication PC Board
LS11219	DOP-116	Power PC Board
LS11220	DHI-150	Display LED Board

Toshiba Elevator Parts



Elevator



GNL Model	Toshiba OEM /Model	Product Name	Product Description
TBE19001	CV180	Push Button	
TBE19002	CV190	Push Button	
TBE19003	CS-41-GG	Push Button	DC5V/24V
TBE19004	A5P00032P00	Push Button	
TBE19005	GS-1A-D	Push Button	
TBE19006	5P1N748P004-A	Push Button	
TBE19007	A4N52207	Push Button	34*34mm
TBE19008	PB5-102	Push Button	
TBE19009	CV55	Door Hanger	
TBE19010	HNL90	Roller Guide Shoe	70*25/90*30*6202
TBE19011	RG-70A	Roller Guide Shoe	70*25 6202
TBE19012	GKG38-DX01002	Guide Shoe Roller	70*25/90*30 6202
TBE19013	CV60	Door Lock Set	Right/Left
TBE19014		Door Lock Roller	40*20 ID:18
TBE19015		Door Lock Roller	40*14 6201 ID:12
TBE19016		Door Lock	
TBE19017		Triangular Lock	
TBE19019	CV100	Door Lock Set	
TBE19020		Door Lock Contact	
TBE19022		Door Slider	
TBE19023		Door Slider	
TBE19025	CV620	Door Vane	
TBE19026	SF84M12-51AP	Fan	



Toshiba Elevator Parts

ELEVATOR



TBE19027



TBE19028



TBE19029



TBE19030



TBE19031



TBE19032



TBE19033



TBE19036



TBE19037



TBE19039



TBE19044



TBE19045



TBE19047



TBE19048



TBE19049



TBE19051



TBE19053



TBE19054



TBE19055



TBE19056



TBE19057



TBE19058



TBE19059

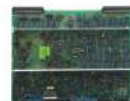

TBE19064



TBE19065



TBE19066



TBE19069

GNL Model	Toshiba OEM /Model	Product Name	Product Description
TBE19027	FV140	Fan	115V / 220V
TBE19028		Guide Shoe Insert	Two 150*30*5, One 150*25*5
TBE19029		Guide Shoe Insert	Two 220*45*95, One 220*34*9
TBE19030		Guide Shoe Insert	one 230*34*9.4, Two 230*36*9.4
TBE19031		Guide Shoe Insert	Two 150*36*5, One 150*26*5
TBE19032		Guide Shoe Insert	Two 120*24*6, One 120*28*6
TBE19033	ZKIN0664G002	Guide Shoe	150*10/16
TBE19036		Hanger Roller	60*16 6203Z
TBE19037		Hanger Roller	72*15 6202
TBE19039		Hanger Roller	56*14 6201 GD:49 ID:12
TBE19044		Roller	73*11 6200 ID:10
TBE19045		Roller	73*11
TBE19047	LSE133-RLU1/U2/QLU3/U4	Limit Switch	
TBE19048	QFU1/QFU2	Limit Switch	
TBE19049	LSE133-RC1	Limit Switch	
TBE19051	BCU-2N UCE6-13B 2N1M3161-A	PC Board	
TBE19053	CCNU-NLB UCE1-308C3 2N1M3292-A	PC Board	
TBE19054	CN-100A UCE4-306L5 2N1M3286-C	PC Board	
TBE19055	COP-100L 5P1M1228P002 UCE1-325C4	PC Board	
TBE19056	DCU-150 UCE4-3M9 2N1M3228-E	PC Board	
TBE19057	DIO-N UCE4-72L1 2N1M3132-B	PC Board	
TBE19058	HIB-100A SP1M1235C UCE1-326C3	PC Board	
TBE19059	IO-150 UCE4-333L4 2N1M3296-A	PC Board	
TBE19064	MCU-VF2A UCE12-22A28 2N1M3176-B	PC Board	
TBE19065	PU-200A UCE1-414C2 5P1M1428	PC Board	
TBE19066	PU-MLT2-A	PC Board	
TBE19069	LSIF4A UCE4	PC Board	



Elevator



HNE22001



HNE22002



HNE22003



HNE22004



HNE22005



HNE22006



HNE22007



HNE22008



HNE22009



HNE22010



HNE22011



HNE22012



HNE22013



HNE22014

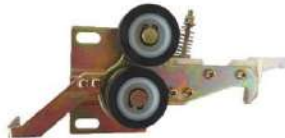

HNE22015



HNE22016



HNE22017



HNE22018



HNE22019



HNE22020



HNE22021



HNE22022

GNL Model	HYUNDAI OEM /Model	Product Name	Product Description
HNE22001	A4J47113	Push Button	
HNE22002	MTD-160	Push Button	
HNE22003	KAN-J0603	Push Button	
HNE22004		Door Slider	86*43*11
HNE22005		Door Slider	
HNE22006		Door Slider	
HNE22007		Door Slider	
HNE22008	DTRE.1024PWFJ	UNITEC ENCODER	
HNE22009		Triad Guide Shoe Insert	120*22*6
HNE22010		Guide Shoe	80*50*57*7
HNE22011	162C098G03	Door Lock Set	
HNE22012		Door Lock Roller	Size: 45*15
HNE22013		Door Lock Contact Set	
HNE22014		Door Lock	
HNE22015		Door Lock	
HNE22016		Door Lock	
HNE22017	GLKS-M34	Car Switch	
HNE22018	PF125-8DN	Proximity Switch	
HNE22019	SLB25-Z8NK-XD	Switch	
HNE22020	SN-GDC-3P	Proximity Switch	
HNE22021		Traction Sheave	500*6*10
HNE22022		Traction Sheave	620*5*12



HYUNDAI Elevator

Elevator

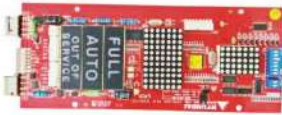

HNE22023



HNE22024



HNE22025



HNE22026



HNE22027



HNE22028



HNE22029



HNE22030



HNE22031



HNE22032



HNE22033



HNE22034



HNE22035

GNL Model	HYUNDAI OEM /Model	Product Name	Product Description
HNE22023	HIPD-CAN V3.2	Vertical Display Board	
HNE22024	HIPD-CAN V3.1	Horizontal Display Board	
HNE22025	204C1583	STD-K105 Inverter PC Board	
HNE22026	280C288H13	OPB-340 PC Board	
HNE22027	204C2041H12	M33BD PC Board	
HNE22028	204C2348	CCB-7 PC Board	
HNE22029	204C2467 H22	TCB-3 PC Board	
HNE22030	HIDC-N Rev 1.2	PC Board	
HNE22031	263C238	Display PC Board	
HNE22032	S204C008	XDDY-12V V3.3 PC Board	
HNE22033	INV2-ICBD	PC Board	
HNE22034	DI-INT-7A-M	PC Board	
HNE22035	204C2089 H23	CTB-1 PC Board	

Fujitec Elevator Parts



Elevator



FUE17001



FUE17002



FUE17003



FUE17004



FUE17005



FUE17006



FUE17007



FUE17008



FUE17009



FUE17010



FUE17011



FUE17012



FUE17013



FUE17014



FUE17015



FUE17016



FUE17017



FUE17018



FUE17019



FUE17020



FUE17021



FUE17022



FUE17023



FUE17024



FUE17025



FUE17026



FUE17027



FUE17028



FUE17029



FUE17030

GNL Model	Fujitec OEM /Model	Product Name	Product Description
FUE17001	A4J10631A	Push Button	
FUE17002	C5FG-A1AN11	Push Button	
FUE17003	HSA7000	Push Button	
FUE17004	BH-253	Door Lock Contact	
FUE17005	BH-253	Door Lock Contact	
FUE17006	5245AS	Door Interlock	
FUE17007	5245AN	Door Interlock	
FUE17008	MKG161-06 / LK-02	Door Interlock	
FUE17009		Door Lock Roller	38*16 ID:14
FUE17010		Door Lock Roller	30*16 ID:14
FUE17011	5238AAHC1	Door Vane	
FUE17012		Door Slider	
FUE17013		Door Slider	
FUE17014		Door Slider	
FUE17015		Guide Shoe	
FUE17016		Guide Shoe	220*16/10
FUE17017		Guide Shoe Insert	One 120*28*6, Two 120*24*9
FUE17018		Guide Shoe Insert	One 120*28*6, Two 120*24*6
FUE17019	FB-2B	Cabin Fan	
FUE17020		Hanger Roller	68*14 6202
FUE17021	VS20 G04	PC Board	
FUE17022	SS-070319	PC Board	
FUE17023	BC20A	PC Board	
FUE17024	CIA-IF118	PC Board	
FUE17025	CP28B	PC Board	
FUE17026	CP38A / CP38B	PC Board	
FUE17027	CPC1 F/HS	PC Board	
FUE17028	IF61A/B/C/D/F	PC Board	
FUE17029	IF66C/B	PC Board	
FUE17030	IF67	PC Board	



Fujitec Elevator Parts

Elevator



FUE17031



FUE17032



FUE17033



FUE17034



FUE17035



FUE17036



FUE17037



FUE17038



FUE17039

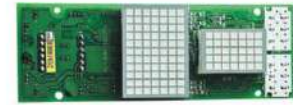

FUE17040

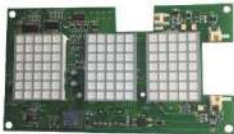

FUE17041



FUE17042



FUE17043



FUE17044



FUE17045

GNL Model	Fujitec OEM /Model	Product Name	Product Description
FUE17031	IF68	PC Board	
FUE17032	IF71B	PC Board	
FUE17033	IF78A	PC Board	
FUE17034	IF82D	PC Board	
FUE17035	IFC1 F/HS	PC Board	
FUE17036	IFC2 F/HS	PC Board	
FUE17037	IN68	Display Board	
FUE17038	IN83	Display Board	
FUE17039	IN86A	PC Board	
FUE17040	IN87B	Display Board	
FUE17041	IN89	Display Board	
FUE17042	INC1A	Display Board	
FUE17043	INC2	Display Board	
FUE17044	MC15	PC Board	
FUE17045	VS16	PC Board	

HITACHI Elevator Parts



Elevator



GNL Model	HITACHI OEM /Model	Product Name	Product Description
HCE15001	SFM-27	Buzzer DC 3V-24V	
HCE15002	YPVF	Arriving Bell	
HCE15004	RL1-MA	Push Button (3 Lines)	
HCE15005	RL1-MA	Push Button (4 Lines)	
HCE15006	AL-POB	Push Button	
HCE15007	SL-TC	Push Button	
HCE15008	DL-PO2(GN085)	Push Button	
HCE15011	EL-PO	Push Button	
HCE15012	AL-POB	Push Button	
HCE15013	CL-PO	Push Button	
HCE15017	GF-971L	Fan	
HCE15019	3115PS-23T-B30	Cooling Fan	
HCE15024		COP Lock	
HCE15025		Car Door Hanger(SET)	
HCE15026		Landing Door Hanger(SET)	
HCE15027		Car Door Hanger OP800/900	
HCE15033		Landing Door Triangular Lock	
HCE15034		Wheel for Door Lock	45*15 ID:12
HCE15035	HY-GR	Door Lock Set	
HCE15036		Door Lock Contact	
HCE15037	DK-RN4	Door Lock	
HCE15038	AZ-05	Door Contact Switch	
HCE15040	LL22140021 & LL36520027	Door Lock Set DK-RS With UL-Q1	
HCE15041	LL36520027	Door Lock Contact UL-Q1	
HCE15044		Door Lock Contact	
HCE15046	TOG-MS-3	DC Door Motor	DC110V
HCE15049		Door Slider	
HCE15050		Door Vane	



HITACHI Elevator Parts

ELEVATOR



HCE15051



HCE15052



HCE15053



HCE15054



HCE15055



HCE15056



HCE15057



HCE15058



HCE15059



HCE15060



HCE15061



HCE15062



HCE15063



HCE15064



HCE15071



HCE15072



HCE15073



HCE15074



HCE15075



HCE15076



HCE15077



HCE15078



HCE15081



HCE15082



HCE15083

GNL Model	HITACHI OEM /Model	Product Name	Product Description
HCE15051		Door Vane Roller	45*15 ID:12
HCE15052	KS-53L	Door Vane	
HCE15053		Door Hanger	170*150
HCE15054	TS5208N10 / TS5208N23	OIH Encoder	
HCE15055	TS3422N6	Encoder	
HCE15056	TS5208N122	Encoder	
HCE15057	HES-0512-2MHC	Encoder	
HCE15058	TS5208N130	Encoder	
HCE15059	TS5208N13	Encoder	
HCE15060	TS6238N352	Encoder	
HCE15061	TS5233N558	Encoder	
HCE15062	H50-GE	Contactor	
HCE15063	H20-GE	Contactor	
HCE15064	H35-GE	Contactor	
HCE15071	SC-N4 (80)	Contactor	
HCE15072		Guide Shoe Insert	Size: 127/121*28 16mm
HCE15073		Guide Shoe Insert	Size: 127/121*28 10mm
HCE15074	YA012B029	Guide Shoe	
HCE15075		Roller Guide Shoe	108*16
HCE15076		Guide Shoe 16mm	
HCE15077		Guide Shoe 10mm	
HCE15078		Guide Shoe 16mm	
HCE15081		Guide Shoe 125*10/16mm	
HCE15082		Roller for Guide Shoe	Size: 160*30*2 6004 ID:20
HCE15083		Guide Shoe Insert	65*24*17

HITACHI Elevator Parts



Elevator



HCE15084



HCE15085



HCE15089



HCE15090



HCE15092



HCE15093



HCE15094



HCE15095



HCE15097



HCE15098



HCE15101



HCE15136



HCE15140



HCE15158



HCE15159



HCE15160



HCE15161



HCE15162



HCE15163



HCE15164



HCE15165

GNL Model	HITACHI OEM /Model	Product Name	Product Description
HCE15084		Oil Can	
HCE15085		Oil Can	
HCE15089		LOP Lock With Key	
HCE15090		Hanger Roller	Size: 65*13 6202RS ID:15
HCE15092		Under Hanger Roller	Size: 33*10 - M10
HCE15093		Wheel for Door Lock	Size: 46*26 6200
HCE15094	LD610D / 13501657-A	Main Interphone	
HCE15095	DJ-BB-6 / 13503668-B	Interphone Sub-Phone	
HCE15097		Interphone Power Supply	
HCE15098	HY-WDJ-F	Interphone	
HCE15101	H1607511	Traction Sheave	Size: 514*12*4
HCE15136	RB-ZD01	Break Controller	
HCE15140	NDS-3UAX	Leveling Sensor	
HCE15158	YG-3 / RM-A	Magnetic Sensor	
HCE15159	RM-DYA1	Magnetic Sensor DC 110V	
HCE15160	RM-YA3	Magnetic Sensor DC 24V	
HCE15161	TKB-1A	Limit Switch Normal Open	
HCE15162	TKB-1B	Limit Switch Normal Close	
HCE15163	LX-21	Limit Switch	
HCE15164	LX-22	Limit Switch	
HCE15165	LX-P	Limit Switch	



HITACHI Elevator Parts

Elevator



GNL Model	HITACHI OEM /Model	Product Name
HCE15028	GVF-2 NPH	Display
HCE15029	NPH-2-SCLA-V1.0	Pc Board
HCE15030	SCLA4-V1.1	Pc Board
HCE15031	SCLB-V1.1	Pc Board
HCE15032	NPH-2-SCLA-V1.0	Pc Board
HCE15104	INV3-ANN	PC Board
HCE15105	INV3-IOCB (R-Q30003407)	PC Board
HCE15106	MTB-CPS4	PC Board
HCE15107	B95I-HSB (R-B 32379032-1)	PC Board
HCE15108	INV2-EMPU	PC Board
HCE15109	INV2-ICBD	PC Board
HCE15110	INV2-HAD	PC Board
HCE15111	MTB-HLNF	PC Board
HCE15112	MTB-HLND	PC Board
HCE15113	MTB-HLGS	PC Board
HCE15114	MTB-CLVL	PC Board
HCE15115	LDM-MIGV	PC Board
HCE15116	MTB-CMU	PC Board
HCE15117	PM300RSD060	Power Module
HCE15119	2DI300A-050D	Power Module
HCE15120	INV2-SAES	PC Board
HCE15121	INV3-3GD	PC Board
HCE15124	B95I-HMDB R-C	Display

GNL Model	HITACHI OEM /Model	Product Name
HCE15125	INV-BDCC3	PC Board
HCE15126	INV-FIO4	PC Board
HCE15127	INV-MPU4	PC Board
HCE15128	ELV-CH-A3 / E273911 / Y2011931	Power Supply Board
HCE15132	INV-FIO5	PC Board
HCE15133	INV-SDC5	PC Board
HCE15134	INV-SDC9	PC Board
HCE15135	MTB-KLN	PC Board
HCE15137	SCLC-V1.1	Display
HCE15141	DMC-1	Pc Board
HCE15142	DMD-1	Pc Board
HCE15143	GHE-FMT	Main PC Board
HCE15144	SDB-02	Frequency Demultiplication PC Board
HCE15145	IOSB / 12501749	Relay Board
HCE15148	IOSB / 12500925	Relay Board
HCE15149	INV3-AMPU2	Main PC Board
HCE15150	INV-AVRA7 / 31107577	ACR Board
HCE15151	UA2-IORB / 12516432	PC Board
HCE15152	UA-GDCB	PC Board
HCE15153	UA2-HSB / 32474763	PC Board
HCE15154	FDB-02	PC Board
HCE15156	UA2-HLND	PC Board
HCE15157	GVF3 / 12502058	Relay Board

Fermator Elevator Parts



Elevator



FTE10001



FTE10002



FTE10003



FTE10004



FTE10005



FTE10006



FTE10007



FTE10008



FTE10009



FTE10010



FTE10011



FTE10012



FTE10013



FTE10014



FTE10015



FTE10016



FTE10017



FTE10018



FTE10019

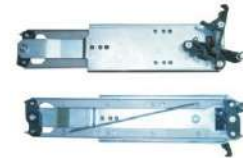

FTE10020

GNL Model	Fermator OEM /Model	Product Name	Product Description
FTE10001	VCI.VF4ACD0EE	VVVF4+ Door Controller	
FTE10002	VCI.VF5ACD0EE	VVVF5 Door Controller	
FTE10003	ACJ.0000.RI000	Triangle Lock	Left/Right
FTE10004	ACJ.0000.RD000	Triangle Lock	Left/Right
FTE10005	CPP.4000RD100	Landing Door Lock	Left
FTE10006	CPP.4000RD000	Landing Door Lock	Right
FTE10007	KEN.4000RC200	Landing Door Lock	Left
FTE10008	KEN.4000RC200	Landing Door Lock	Right
FTE10009	K200K300	Landing Door Lock	Left/Right
FTE10010	ADS-0000R0000	Door Key	
FTE10011	KCE.604000000	Door Lock Contact	
FTE10012	F-005546	Door Lock Contact	
FTE10013	F-000419	Door Lock Contact	
FTE10014	YVP90-6S	Door Motor	
FTE10015	PPM.VFEC.C0000	Door Motor Sprocket	
FTE10016	CSK.VF00.CI000	Door Vane	Left/Right
FTE10017	CSK.CO00CC200	Door Vane	Left/Right
FTE10018	CDL.VF58CD000	Door Vane	Left/Right
FTE10019	CSK.Q001.CI000	Door Vane	Left/Right
FTE10020	M03109	Door Vane	Left/Right



Fermator Elevator Parts

Elevator



FTE10021



FTE10022



FTE10023



FTE10024



FTE10025



FTE10026



FTE10027



FTE10028



FTE10029



FTE10030



FTE10031



FTE10032

GNL Model	Fermator OEM /Model	Product Name	Product Description
FTE10021	CDL.P000CD000	Door Vane	Left/Right
FTE10022	PFR0200.00000	Hanger Roller	48*14 6002
FTE10023	PFR0200.169005	Hanger Roller	48*14 6002
FTE10024	PFR0700.00000	Hanger Roller	62mm 6200
FTE10025	PFR.0400.00000	Hanger Roller	33*15*M10
FTE10026	AGH.01P000000	Door Slider	
FTE10027	AGH.02P000000	Door Slider	
FTE10028	PPS.90AE.RC4AL1900	Door Sill	
FTE10029	HTD-5M	Door Belt	
FTE10030	CHT.EA00C0000	Door Belt Clip	
FTE10031	VCP.VFCP.C0000.CAN	Service Tool/Test Tool	
FTE10032	PPM-PMEA.C0000	Motor Pulley	

KONE Escalator Parts



Escalator



GNL Model	Fermator OEM /Model	Product Name	Product Description
KNS7001		Escalator Step	
KNS7003	DEE2258672	SLIDE BUSHING	D30MM L=45MM
KNS7004		Movingwalk Pallet	
KNS7006	KM5212360G01	Stainless Steel Step	
KNS7008	KM5009368G01	Roller Asm.	L:200,W:90,Roller D:Φ70
KNS7010	DEE4008754 / KM3685362	Roller	Φ75X23 6204 ID:20
KNS7011	DEE3685360 / DEE4049340	Roller	Φ75X23 ID:20.1
KNS7012	KM882095	Roller	Φ100X19 6204 ID:20
KNS7013	DEE4008753	Roller	Φ100X25 6204 ID:20
KNS7014	DEE2208198	Roller	Φ75X19 6204 ID:20
KNS7016	KM5009302G01	Roller Asm.	L:74,W:60 6202
KNS7017	KM5071592G01	Support Roller	L:65,W:76,Roller 60*64
KNS7018	KM5009374G01	Roller Asm.	L:74,W:69.5 Roller:60*32
KNS7019	DEE3691791	Handrail Roller	L:80,W:60,Roller:60*64
KNS7020	DEE3691796	Handrail Roller	L:90,W:75,Roller 60*64
KNS7021	DEE1764102	Roller Bow	R770MM
KNS7022	DEE1563839	Roller Bow	R970MM D60MM W=78MM
KNS7023	DEE1972307	Step Roller	Φ110X20 6204 ID:20
KNS7024	KM86789G02	Roller	80*28 6203Z ID:17
KNS7026	DEE2173045	Handrail Base Roller	60*64 6204
KNS7029	KM5284799H01	Escalator Roller	110*27 6204 ID:20
KNS7030	DEE1788494	Skeleton Roller	Φ110X19 6303 ID:17
KNS7034	DEE2426406	Seal Strip/Joint Strip	
KNS7037	KM5279513H01	Skirt Brush Base	
KNS7038	KM51344338	Skirt Brush End Cap	
KNS7039	KM4063909H01	Skirt Brush	



KONE Escalator Parts

Escalator



KNS7040



KNS7041



KNS7042



KNS7043



KNS7044



KNS7045



KNS7046



KNS7047



KNS7048



KNS7049



KNS7050



KNS7051



KNS7052



KNS7053



KNS7054



KNS7055



KNS7056



KNS7057



KNS7058



KNS7059



KNS7060



KNS7061



KNS7062



KNS7097

GNL Model	KONE OEM /Model	Product Name	Product Description
KNS7040	KM5070885G01	Inlet Fastening	
KNS7041	KM5072746G01	Inlet Fastening	
KNS7042		Inlet Fastening	
KNS7043	5072734D10,5072740D10	Inlet Cover	L:216,W:130.5/126.5
KNS7044	5072733D10,5072730D10	Inlet Cover	L:216,W:130.5/126.5
KNS7045	KM929486	Inlet Cover	L:216,W:130.5/126.5
KNS7046	KM929487	Inlet Cover	L:216,W:130.5/126.5
KNS7047	5072738D10,5072736D10	Inlet Cover	L:216,W:130.5/165
KNS7048	DEE3688671	Inlet Cover	
KNS7049	DEE4001871	Inlet Cover	L:263,W:130,Thickness:10
KNS7050	DEE4001877	Inlet Cover	L:263,W:130,Thickness:10
KNS7051	DEE4001872	Inlet Cover	L:263,W:126,Thickness:10
KNS7052	DEE4001875	Inlet Cover	L:263,W:126,Thickness:10
KNS7053	KM929484	Inlet Cover	
KNS7054	KM929485	Inlet Cover	
KNS7055	KM929449	Inlet Cover	
KNS7056	KM949718	Handrail Inlet	
KNS7057	KM5232308H01	Handrail Inlet	
KNS7058	KM5202470H01	Handrail Inlet	143X96MM
KNS7059	KM4062490H01	Handrail Inlet	143X86MM
KNS7060	DEE4012240	Handrail Inlet	143X86MM
KNS7061	DEE2738748	Handrail Inlet	
KNS7062	KM5273099G02	Handrail Inlet	
KNS7097	KM5002050H01	R3C Comb plate	202*200*99 T22

KONE Escalator Parts



Escalator



KNS7098



KNS7099



KNS7100



KNS7101



KNS7102



KNS7104



KNS7105



KNS7106



KNS7107



KNS7108



KNS7109



KNS7110



KNS7111

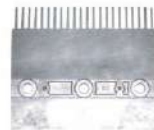

KNS7112



KNS7113



KNS7114



KNS7115



KNS7116



KNS7117



KNS7118



KNS7119

GNL Model	KONE OEM /Model	Product Name	Product Description
KNS7098	KM5002051H01	R3C Comb plate	202*200*99 T22
KNS7099	KM5002052H01	R3C Comb plate	197*200*92 T22
KNS7100	KM5009370H01	Comb Plate	202*132*140
KNS7101	KM3711043	Plastic ECO Comb Plate	197*180*99 T22
KNS7102	KM3711044	Aluminum Comb Plate	197*180*99 T22
KNS7104	DEE2209591	RTV Comb Plate	202.7*189*99
KNS7105	DEE2209592	RTV Comb Plate	202.7*189*99
KNS7106	KM5201831H01	RTV Comb Plate	
KNS7107	DEE3703287	Comb Plate	200*180*99
KNS7108	DEE3703280	Comb Plate	197.6*180*99
KNS7109	DEE3703288	Comb Plate	200*180*99
KNS7110	DEE0786972	A3 Comb Plate	
KNS7111	DEE0786973	B3 Comb Plate	
KNS7112	DEE0786974	C3 Comb Plate	
KNS7113	DEE0786975	D3 Comb Plate	
KNS7114	KM5009380H01	Comb Plate	W=126.1MM
KNS7115	KM5009380H02	Comb Plate	W=126.1MM
KNS7116	KM5130667H01	Comb Plate	200.2*127.2*140 T22
KNS7117	KM5130668H01	Comb Plate	200.2*127.2*140 T23
KNS7118	KM5130669H01	Comb Plate	197.4*127.2*140 T23
KNS7119	KM5009370H02	Comb Plate	202*132*140



KONE Escalator Parts

Escalator



KNS7120



KNS7121



KNS7124



KNS7125



KNS7126



KNS7127



KNS7128



KNS7129



KNS7130



KNS7131



KNS7132



KNS7135



KNS7145

GNL Model	KONE OEM /Model	Product Name	Product Description
KNS7120	KM5009371H01	Comb Plate	202*132*140
KNS7121	KM5009371H02	Comb Plate	202*132*140
KNS7124	KM5232300G09	Reversing Chain	
KNS7125	DEE2758680	Reversing Chain	Pitch Line:45 Width:30.5
KNS7126	KM5071663G04	Reversing Chain	Pitch Line:60 Width:34
KNS7127	DEE1700492	Reversing Chain	D40MM W=24MM
KNS7128	KM5248923G11	Reversing Chain	
KNS7129		Reversing Chain	Pitch Line:46 Width:32.5
KNS7130	KM5070679G01 / KM5232300G03	Reversing Chain	
KNS7131	KM966334	Step Chain	Roller 75*23.5
KNS7132	DEE4048435	Step Chain	Roller 100*25
KNS7135	DEE4052054	Step Chain with Rod	
KNS7145	DEE3721645	Belt	L=2500MM S=8MM W=29MM

Mitsubishi Escalator Parts



Escalator



MTS5001



MTS5002



MTS5003



MTS5005



MTS5006



MTS5009



MTS5010



MTS5011



MTS5012



MTS5013



MTS5014



MTS5015



MTS5016



MTS5017



MTS5018

GNL Model	Mitsubishi OEM /Model	Product Name	Product Description
MTS5001	YS013B521	Demarcation Strip	Right
MTS5002	YS013B522	Demarcation Strip	Left
MTS5003	YS004B278	Demarcation Strip	Center, 44T
MTS5005	J619000B202	Demarcation Strip	Left; Length:409 Thick:13.6 Width:103
MTS5006	J619000B203	Demarcation Strip	Right; Length:409 Thick:13.6 Width:99
MTS5009	L47332141A	Demarcation Strip	for Stainless Steel Step
MTS5010	L47332141B	Demarcation Strip	for Stainless Steel Step
MTS5011	L47332142C	Demarcation Strip	for Stainless Steel Step
MTS5012	L47332142D	Demarcation Strip	for Stainless Steel Step
MTS5013	L47332143D	Demarcation Strip	for Stainless Steel Step
MTS5014	L47332145A	Demarcation Strip	LEFT, Length:199mm, Width:32mm
MTS5015	L47332145B	Demarcation Strip	RIGHT, Length:199mm, Width:32mm
MTS5016	L47332144A	Demarcation Strip	MIDDLE, Length:153mm, Width:32mm
MTS5017	C719001A201B	Sidewalk Pallet	
MTS5018	J619004A000	Aluminum Step	Angle=30; J619000A201A/J619004A000



Mitsubishi Escalator Parts

Escalator



MTS5021



MTS5022



MTS5023



MTS5025



MTS5026



MTS5027



MTS5028



MTS5029



MTS5030



MTS5034



MTS5035



MTS5036



MTS5038



MTS5039



MTS5040



MTS5041



MTS5042



MTS5043



MTS5046

GNL Model	Mitsubishi OEM /Model	Product Name	Product Description
MTS5021	YS005C686G01	Chain Roller	76*35 6202 Double
MTS5022		Al Drive Roller	Φ132*35 ID:44
MTS5023	YS005C520	Al Bearing Step Roller	Φ76X25 6202 ID:15
MTS5025	J622000C202	Roller	Φ76X25 6202 ID:15
MTS5026		Iron Hub	Φ60X55 6202 Double Bearing ID:15
MTS5027		Press Roller	
MTS5028	C731000C112	YKO-EO242	ESCALATOR MAIN BOARD
MTS5029	C731000B114	SUM630	
MTS5030	YS101B034-01	DHL Brake	DHL-120N-M
MTS5034		Wearing strip	
MTS5035		Gliding Bushing	ID:25
MTS5036		Gliding Bushing	ID:25
MTS5038		Gear	22T
MTS5039		Gear with bearing	30T
MTS5040	YS017B313	Comb Plate	Yellow, install hole=62mm
MTS5041	YS017B313	Comb Plate	Black, install hole=62mm
MTS5042	YS017B578	Comb Plate	Yellow, install hole=80mm
MTS5043	YS017B578	Comb Plate	Black, install hole=80mm
MTS5046		Step Chain	Pitch=68.4, install hole=25mm, shafts distance=410.4mm

OTIS Escalator Parts



Escalator



OTS3005



OTS3007



OTS3008



OTS3009



OTS3010



OTS3011



OTS3014



OTS3016



OTS3017



OTS3018



OTS3021



OTS3025



OTS3026



OTS3030



OTS3031



OTS3032



OTS3033



OTS3034

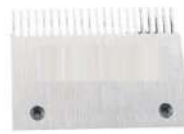

OTS3037



OTS3038

GNL Model	OTIS OEM /Model	Product Name	Product Description
OTS3005	GOA717A1	OTIS 506 Belt	2476mm
OTS3007	GO222P1	Brake	
OTS3008		OTIS 606 Step chain	
OTS3009		Reversing Chain	Pitch Line:60/45 W:33.6 Twin fork
OTS3010		Driving Chain	Pitch Line:70 OD Of Roller:Φ60 W:55 Link W X Thickness:35X3
OTS3011		Step chain	Pitch Line:131.33 OD Of Roller:Φ76.2 Link W X Thickness:30/35X5 14.63
OTS3014		XIZI OTIS Chain	Roller ID=80mm, T131
OTS3016		XIZI OTIS Tension And Protection	
OTS3017		XIZI OTIS Tension And Protection	
OTS3018	GAA332Z4	Driving Chain	
OTS3021		Reversion Chain	3-bearing, 17-section
OTS3025	CSA00C021A	GSD140 Coil	
OTS3026	DAA610E1	CGM-3T Coil Starter	
OTS3030	XAA453J	Aluminium Alloy Comb Plate	L:193.2, H:145.3, H.S:142.8, T.P.:8.4 Remark:Aluminum Center
OTS3031	XAA453J	Aluminium Alloy Comb Plate	L:214.2, H:145.3, H.S:142.8, T.P.:8.4 Remark:Aluminum Left
OTS3032	XAA453J	Aluminium Alloy Comb Plate	L:214.2, H:145.3, H.S:142.8, T.P.:8.4 Remark:Aluminum Right
OTS3033	GAA453BM1/XAA453CD1	Comb Plate	L:203, H:139.2, H.S:101.7, T.P.:8.4 Remark:Aluminum 24 Teeth Center
OTS3034	GAA453BM6	Comb Plate	L:198, H:139.2, H.S:101.7, T.P.:8.4 Remark:Aluminum 23 Teeth Left
OTS3037	XAA453AV1 PNS1.18-1/2	Comb Plate	L:203 W:145, H.S:145.3, T.P.:9.068 Remark:Aluminum 22 Teeth Right
OTS3038	XAA453AV2 PNS1.18-1/1	Comb Plate	L:199 W:145, H.S:145.3, T.P.:9.068 Remark:Aluminum 22 Teeth Center



OTIS Escalator Parts

Escalator



OTS3040



OTS3041



OTS3042



OTS3043



OTS3044



OTS3046



OTS3047



OTS3048



OTS3049



OTS3050



OTS3051



OTS3052



OTS3053



OTS3054



OTS3055



OTS3056



OTS3057



OTS3064



OTS3066



OTS3067



OTS3068



OTS3072

GNL Model	OTIS OEM /Model	Product Name	Product Description
OTS3040	XAA453AV3 PNS1.18-1/3	Comb Plate	L:203 W:145 , H.S:145.3 , T.P.:9.068 Remark:Aluminum 22 Teeth Left
OTS3041	GAA453BM5	Comb Plate	L:206 , H:139.2 , H.S:101.6 , T.P.:8.4 Remark:Aluminum 24 Teeth LEFT
OTS3042	LDTJ-B-2	Comb Plate	Color:Yellow L:213 , H:107.5 , H.S:142.4 , T.P.:8.4 Remark:Plastic Left
OTS3043	LDTJ-B-3	Comb Plate	Color:Yellow L:192.6 , H:107.5 , H.S:145 , T.P.:9.068 Remark:Plastic Center
OTS3044	LDTJ-B-1	Comb Plate	Color:Yellow L:213 , H:107.5 , H.S:142.4 , T.P.:8.4 Remark:Plastic Right
OTS3046	XAA453BJ1	Aluminium Alloy Comb Plate	203.184*132.64 8.466 101.7 24T,CENTER
OTS3047	XAA453BJ2	Aluminium Alloy Comb Plate	197.994*132.64 8.466 101.7 23T,RIGHT
OTS3048	XAA453BJ3	Aluminium Alloy Comb Plate	206.39*132.64 8.466 101.7 24T,LEFT
OTS3049	GAA453BV1	Aluminium Alloy Comb Plate	203.184*139.2 , 8.466 ,101.7 24T,CENTER
OTS3050	GAA453BV5	Aluminium Alloy Comb Plate	206.39*139.2 , 8.466 ,101.7 24T,LEFT
OTS3051	GAA453BV6	Aluminium Alloy Comb Plate	197.994*139.2 , 8.466 ,101.7 23T,RIGHT
OTS3052	L47312023A	Comb Plate	L:199mm, W: 106mm, H.D.: 145mm, 22T ,Center,Plastic, Yellow
OTS3053	L47312024A	Comb Plate	L:204mm, W: 106mm, H.D.: 145mm, 22T, Left, Plastic, Yellow
OTS3054	L47312022A	Comb Plate	L:204mm, W: 106mm, H.D.: 145mm, 22T, Right, Plastic, Yellow
OTS3055	XAA453AB6	Aluminium Comb Plate	193.2*111.2, Pitch=8.4, Install hole=142.8, 23T
OTS3056	XAA453AB7	Aluminium Comb Plate	214.2*111.2, Pitch=8.4, Install hole=142.8, 25T
OTS3057	XAA453AB8	Aluminium Comb Plate	214.2*111.2, Pitch=8.4, Install hole=142.8, 25T
OTS3064	XAA290CX1	Friction Wheel	455*50*30mm
OTS3066	XAA290CT2	Friction Wheel	587*30*50
OTS3067		Friction Wheel	OD=557mm*30mm,ID=433mm,M12 Has thread in install holes
OTS3068	DAA261NNN1	Friction Wheel	457*35
OTS3072		Friction Wheel	OD=557mm*30mm,ID=433mm,M12 NO thread in install holes

OTIS Escalator Parts



Escalator



GNL Model	OTIS OEM /Model	Product Name	Product Description
OTS3073	XAA385DI	9-Teeth Sprocket With friction teeth	With blue ring
OTS3075	XAA385DI	9-Teeth sprocket With friction teeth	Without blue ring
OTS3076	XAA385X	19-teeth sheave	
OTS3079	XAA835AJ1	Guide Piece	H.D.:13mm,L:93mm
OTS3081	OTIS GAB438BNX①	OTIS 506 ESCALATOR GUIDE RAIL	Al
OTS3082	XAA384KP1	Escalator Return Guide	170*57 H.D.:150
OTS3084	OTIS GAB438BNX2	Escalator Slider	
OTS3090	XAA26220AA1	Inlet Cover Holder	Right
OTS3091	XAA26220AH1	Rubber Inlet	Without brush
OTS3092	GAA26800AR2	Inlet Cover Holder	Left
OTS3094	XAA26220D1	Movable Inspection Box	4 pin
OTS3095	XBA26220AB17	Movable Inspection Box	
OTS3101	XAA26220D2	ECB Board	
OTS3102	GAA456DH1	Switch Box	
OTS3103	GO290AJ11	Switch Box	
OTS3105		KZ11-1100 D1 Switch Box	
OTS3110		Nylon Roller	∅70X34 6201 Double ID:12
OTS3111		Step Roller	∅76X22 6203
OTS3113		Roller	∅80X25 6204 ID:20
OTS3114		Roller	∅80X25 6304 ID:20
OTS3115		Nylon Hub Roller	∅76.2X21.6 ID:19
OTS3120		Roller	∅70X25 6204 ID:20



OTIS Escalator Parts

Escalator



OTS3123



OTS3128

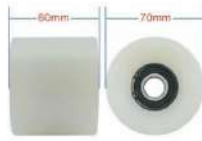

OTS3132

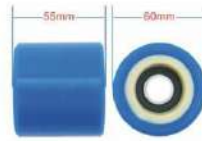

OTS3134



OTS3139



OTS3140



OTS3141



OTS3144



OTS3146



OTS3151



OTS3159



OTS3161



OTS3162



OTS3163



OTS3169



OTS3171



OTS3172



OTS3173



OTS3174



OTS3175



OTS3176



OTS3181



OTS3183



OTS3184



OTS3204

GNL Model	OTIS OEM /Model	Product Name	Product Description
OTS3123		Handrail Drive Wheel	XIZI OTIS 131*30 ID:44
OTS3128	XAA290CY1	Skeleton Roller	Φ76.2X22 6204 ID:20
OTS3132		XIZI OTIS Roller	70*60 6202
OTS3134		Tension Chain Roller	60*55 6202
OTS3139	SLD2-12GM-WH1A	Speed Sensor	
OTS3140	XAA26340H3	Travolater Pallet	
OTS3141	XAA26143A25	Stainless Steel Steps	Size: 1000MM
OTS3144	XAA26145A1	508 Stainless Steel Steps	Size: 1000MM
OTS3146	XAA26340B1	Sidewalk Pallet	
OTS3151	GAA26340H5	606NCT Pallet	1000mm with paint demarcation
OTS3159		Step Sensor	Turck NI25U-CK40-AP6X2-H1141
OTS3161	XAA177BE1	Silicon Controller	
OTS3162	DAA177CD1	Escalator Lock	
OTS3163	GAA177HB1	Hall Switch	RED, PNP, Normal Open, S
OTS3169	DAA177AX2	Hall Switch	
OTS3171	GAA50AHA1	Handrail wearing strip	W=26mm, Thick=6mm(2mm)
OTS3172	XAA455S1	Demarcation Strip	L:404, W:99(25), LEFT
OTS3173	XAA455S3	Demarcation Strip	L:203, W:36, CENTER
OTS3174	L47332137A/B	Demarcation Strip	L:199, W:33, 22T
OTS3175	L47332138A/B	Demarcation Strip	L:154, W:33, 17T
OTS3176	L47332135A	Demarcation Strip	L:199, W:40.5, 22T
OTS3181	H2106212 32188940-M	Demarcation Strip	L:319, T.P.:8.4 W:42
OTS3183	H2106223/224 32188939-M	Demarcation Strip	L:319, T.P.:8.4 W:25.3
OTS3184	LDTJ-A-14	Demarcation Strip	L:395, T.P.:12 Thick W:24.7, LEFT
OTS3204	XAA455K1	Demarcation Strip	L:321.6 W:31.4, T.P.:8.4, BLACK COLOR

OTIS Escalator Parts



Escalator



OTS3205



OTS3211



OTS3212



OTS3213



OTS3214



OTS3215



OTS3216



OTS3217



OTS3218



OTS3219

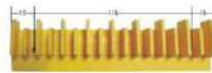

OTS3224



OTS3225



OTS3227



OTS3233



OTS3234



OTS3235



OTS3236



OTS3237



OTS3238



OTS3239



OTS3240



OTS3241



OTS3242



OTS3243

GNL Model	OTIS OEM /Model	Product Name	Product Description
OTS3205	XAA455J1	Demarcation Strip	L:321.6 W:55 , T.P.:8.4, YELLOW COLOR
OTS3211	XAA455L1	Demarcation Strip	L:403 W:24.2 , T.P.:8.4, LEFT
OTS3212	XAA455M1	Demarcation Strip	L:403 W:24.2 , T.P.:8.4, RIGHT
OTS3213	LDTJ-A-14	Demarcation Strip	L:395 , T.P.:12 Thick W:24.7 Right
OTS3214	HEO0528 LL8 034 023	Demarcation Strip	Color:Black L:319 , T.P.:8.4 W:42 Front Thick:25 Front
OTS3215	LL8 034 024	Demarcation Strip	Color:Yellow L:268 , T.P.:8.4 W:24 Front Thick:25 Left
OTS3216	LL8 034 024	Demarcation Strip	Color:Yellow L:268 , T.P.:8.4 W:24 Front Thick:25 Right
OTS3217	L47332136A	Demarcation Strip	Left
OTS3218	L47332127A	Demarcation Strip	L:199, W:40.5, 22T
OTS3219	L47332136B	Demarcation Strip	Right
OTS3224	L47332128A	Demarcation Strip	L:154, W:40.5, 17T
OTS3225	XAA455S2	Demarcation Strip	L:404, W:99(25), LEFT
OTS3227	L47332139A	Demarcation Strip	Rear Right, Long
OTS3233	GAA453BV3	Aluminium Alloy Comb Plate	206.39*139.2, 8.466 ,101.7 24T,LEFT
OTS3234	GAA453BV7	Aluminium Alloy Comb Plate	197.994*139.2, 8.466 ,101.7 23T,RIGHT
OTS3235		Friction Wheel	OD=587mm*30mm,ID=433mm, M12 NO thread in install holes
OTS3236	XAA26220AA21	Movable Inspection Box	8 hole, 5pins
OTS3237	XAA26220AA6/BA10	Movable Inspection Box	8 hole, 3 pins
OTS3238	DBA174PWK79	Movable Inspection Box	
OTS3239	XAA26220BA35	Movable Inspection Box	
OTS3240	OTIS GAB438BNX6	Inlet Cover Holder	Left
OTS3241	OTIS GAB438BNX5	Inlet Cover Holder	Left
OTS3242	XAA384JK1	Rubber Inlet	With brush
OTS3243		Roller	60*64 6204



Schindler Escalator Parts

Escalator



SHS14004



SHS14005



SHS14006



SHS14007



SHS14008



SHS14009



SHS14010



SHS14011



SHS14012



SHS14014



SHS14013



SHS14015



SHS14016



SHS14018



SHS14019



SHS14020



SHS14021



SHS14022



SHS14023



SHS14024

GNL Model	SCHINDLER OEM /Model	Product Name	Product Description
SHS14004	SCS319900	Demarcation Strip	L:202.5 , T.P:9.068 , W:49.6(Front)
SHS14005	SCS319905	Demarcation Strip	L:222 Thick:28 , W:28.5(Right Radian)
SHS14006	SCS319901	Demarcation Strip	L:403 Thick:25 , W:109(Left)
SHS14007	SCS319902	Demarcation Strip	L:403 , T.P:25 Thick , W:96(Right)
SHS14008	SCS319903	Demarcation Strip	L:222 Thick:28 , W:28.5(Left Radian)
SHS14009	BEVG	Demarcation Strip	Left
SHS14010	BEVG	Demarcation Strip	Right
SHS14011	BEVG	Comb Plate	Left
SHS14012	BEVG	Comb Plate	Right
SHS14013		SCREW + CLIP	
SHS14014	BEVG	Comb Plate	Middle
SHS14015		Aluminum Sector Rack	
SHS14016		Motor Coupling Set	
SHS14018		Moving walk Pallet	1128*138mm
SHS14019		Moving walk Pallet	1138*138mm
SHS14020		Escalator Step	
SHS14021		Step with Demarcation	
SHS14022		Aluminum Step	
SHS14023		Aluminum Step	
SHS14024		Aluminum Step	

Schindler Escalator Parts



Escalator



GNL Model	SCHINDLER OEM /Model	Product Name	Product Description
SHS14025		Pallet Bukle	
SHS14030		Friction Pulley	OD:588*30, 6 Mounting Hole
SHS14031		Escalator Roller	Φ70*72
SHS14032		Skeleton Roller	Φ70X25 6204 ID:20
SHS14033		Skeleton Roller	Φ76.2X22 6204 ID:20
SHS14034		Nylon Aluminum Hub Handrail Roller	Φ70X50 6204DU ID:20
SHS14036		Multi-Wedge Belt Sheave	Φ97X70 6204 GD:86 Double Bearing ID:20
SHS14037		Multi-Wedge Belt Sheave	Φ89.5X70 6204 Double Bearing GD:85.4 ID:20
SHS14038		Multi-Wedge Belt Sheave	Φ85X70 6204 Double Bearing ID:20
SHS14039	SSEF50110	Roller	Φ70X25 6204 ID:20
SHS14040	SSEF50110	Roller	Φ70X25 6204 ID:20
SHS14041		Central Wheel	ID:35
SHS14042		Guide Roller	
SHS14043		Blue Step Roller	Φ76*25 6202
SHS14044		ROLLER	76*25 6204
SHS14047	SCS409172	Stopper	
SHS14048		Joint Strip	
SHS14049		Sliding pece	
SHS14050		Clamp	
SHS14053	ID.NR. 398765	PC Board	
SHS14054	ID.NR. 590811	9300 Escalator PC Board	
SHS14055	KZ-720B	Inspection Box	
SHS14056		Key Switch	
SHS14057		Inlet Cover	
SHS14058		Inlet Cover	
SHS14059		Rubber Inlet	
SHS14060		Inlet Brush	



Schindler Escalator Parts

Escalator



SHS14061



SHS14062



SHS14063



SHS14064



SHS14074



SHS14075



SHS14076



SHS14077



SHS14079



SHS14080



SHS14081



SHS14084



SHS14085



SHS14087



SHS14088



SHS14089



SHS14092



SHS14093



SHS14094



SHS14095



SHS14097



SHS14099

GNL Model	SCHINDLER OEM /Model	Product Name	Product Description
SHS14061	SML244157	POM-H	Polyurethane Sliding Rail
SHS14062			Polyurethane Sliding Rail
SHS14063			Guide Piece
SHS14064			Guide Piece
SHS14074	SMR313609		9300 Comb Plate
SHS14075	SMR57410420		9300 Comb Plate
SHS14076	SMR57410421		9300 Comb Plate
SHS14077			Comb Plate
SHS14079	A305004N		Comb Plate
SHS14080			Comb Plate
SHS14081			Comb Plate
SHS14084	SDS		Reversing Chain
SHS14085	SWE		Reversing Chain
SHS14087			Sidework Chain
SHS14088			Chain
SHS14089	SDS		Reversing Chain
SHS14092			Electrostatic Discharged Brush
SHS14093			Brake
SHS14094	ID.NR.897200		Brake (single action solenoid)
SHS14095			Brake Band
SHS14097			Multi-Wedge Rubber Belt
SHS14099			Anti-static roller

ThyssenKrupp Escalator Parts



Escalator



TYS9004



TYS9005



TYS9006



TYS9008



TYS9009



TYS9010



TYS9011



TYS9012



TYS9013



TYS9015



TYS9016



TYS9017



TYS9018



TYS9022



TYS9023



TYS9024



TYS9025



TYS9026



TYS9027



TYS9028



TYS9029



TYS9030



TYS9033



TYS9034



TYS9036

GNL Model	THYSSENKRUPP OEM /Model	Product Name	Product Description
TYS9004		Demarcation Strip	L:284.5 , T.P:8.5 , W:33.3 Thick:14.2
TYS9005		Demarcation Strip	L:327.8 , T.P:8.5 , W:33.3 Thick:14.2
TYS9006		Demarcation Strip	L:410.2 , T.P:8.5 , W:26 Thick:14.2 Left
TYS9008		Demarcation Strip	L:410.2 , T.P:8.5 , W:26 Thick:14.2 Right
TYS9009	L47332155A	Demarcation strip	
TYS9010	L47332153B	Demarcation strip	15teeth
TYS9011	L47332154A	Demarcation strip	
TYS9012		Escalator Step	L=1000mm, Al, w/o strip, Special teeth
TYS9013		Escalator Step	L=1000mm, Al, w/o strip, normal teeth
TYS9015		Roller	Φ80X53 6204 Double Bearing
TYS9016		Multi-Wedge Belt Sheave	Φ111X60 6304 Double Bearing
TYS9017		Roller	Φ80X60 6204
TYS9018	1705060100	Roller	Φ75X24 6204
TYS9022		Inlet Cover	with holes
TYS9023		Inlet Cover	without switch holes
TYS9024		Slider	HANDRAIL GUIDE PIECE
TYS9025		Friction Wheel	690/555*35, w/o triangle iron.
TYS9026		Friction Wheel	690/555*35, include triangle iron.
TYS9027		Power Lock with Stop Button	
TYS9028		Comb Plate	
TYS9029		Comb Plate	L:204 , H:115.8 , H.S:66 , T.P:8.4 , RMK:Aluminum 3 Holes 24 Short Teeth
TYS9030		Comb Plate	L:204 , H:127.8 , H.S:66 , T.P:8.4 , RMK:Aluminum 3 Holes 24 Long Teeth
TYS9033		Reversing Chain, 24-Roller	
TYS9034		Step Chain	
TYS9036		Roller	Φ100X34 6204



LG Sigma Escalator Parts

Escalator



LSS12001

LSS12002

LSS12003

LSS12004

LSS12005

LSS12006

LSS12007



LSS12008



LSS12009



LSS12010



LSS12011



LSS12012



LSS12013



LSS12014



LSS12015



LSS12016

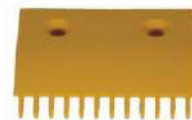

LSS12017

GNL Model	LG Sigma OEM /Model	Product Name	Product Description
LSS12001	H2106211	Demarcation Strip	
LSS12002	H2106223	Demarcation Strip	
LSS12003	1L05214-R	Demarcation Strip	
LSS12004	1L05214-L	Demarcation Strip	
LSS12005	2L05913-M	Demarcation Strip	
LSS12006	2L05914-M	Demarcation Strip	
LSS12007	2L09005-MS	Demarcation Strip	
LSS12008	L48034005A	Demarcation Strip	
LSS12009	L48034020A	Demarcation Strip	
LSS12010	DSA2001488B-R	Comb Plate	
LSS12011	DSAT00C318	Comb Plate	L:203, H.S:110, T.P:8.4, 24T
LSS12012	DSA2000903	Comb Plate	L:206, H.S:110, T.P:8.4, 24T
LSS12013	DSAT00C112	Comb Plate	L:197, H.S:110, T.P:8.4, 23T
LSS12014	DSA2000905	Comb Plate	L:205, H.S:110, T.P:8.4, 24T
LSS12015	DSA2000904	Comb Plate	L:199, H.S:110, T.P:8.4, 23T
LSS12016	2L08318	Comb Plate	L:160, H.S:90, H:90 T.P:9, 17T
LSS12017	2L08316	Comb Plate	L:109, H.S:90, H:60 T.P:9, 12T

LG Sigma Escalator Parts



Escalator



LSS12018



LSS12019



LSS12020



LSS12021



LSS12022



LSS12023



LSS12024



LSS12025



LSS12026



LSS12027



LSS12028



LSS12029



LSS12030



LSS12031



LSS12032



LSS12033



LSS12034

GNL Model	LG Sigma OEM /Model	Product Name	Product Description
LSS12018	2L08319	Comb Plate	L:145, H.S:90, H:90 T.P:9, 16T
LSS12019	2L08317	Comb Plate	L:160, H.S:90, H:90 T.P:9, 17T
LSS12020	DSA2000168-L	Comb Plate	L:146, H.S:90, H:94 T.P:8, 17T
LSS12021	DSA2000168-R	Comb Plate	L:146, H.S:90, H:94 T.P:8, 17T
LSS12022	DSA2000169-M	Comb Plate	L:142, H.S:90, H:94 T.P:8, 17T
LSS12023	2L05754	Comb Plate	
LSS12024	2L05755	Comb Plate	
LSS12025	2L05753	Comb Plate	
LSS12026	DSA2001488A-L	Comb Plate	
LSS12027	DSA2001489-M	Comb Plate	
LSS12028		Stainless Steel Step	
LSS12029		Aluminum Step	
LSS12030	XJ1000LG-A	Stainless Steel Pallet	
LSS12031		Step Roller	80*22 6204 ID:20
LSS12032		Friction Pulley	OD:458*35 ID:45
LSS12033		Handrail Press Roller	OD:90, ID:64mm
LSS12034		Handrail Press Roller	OD:70*68, ID:59



Toshiba Escalator Parts

Escalator



TBS21001



TBS21002

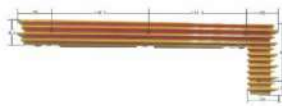

TBS21003



TBS21004



TBS21005



TBS21006



TBS21007



TBS21008



TBS21009



TBS21010



TBS21011



TBS21016



TBS21017



TBS21018



TBS21019

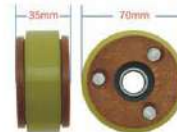

TBS21020



TBS21021

GNL Model	Toshiba OEM /Model	Product Name	Product Description
TBS21001	5P1P5582P001/0129CAC001	Demarcation Strip	L:205, W:49.5, T: 22T.
TBS21002	5P1P5581P002	Demarcation Strip	L:402 W:96.
TBS21003	5P1P5581P001	Demarcation Strip	L:402 W:96.
TBS21004	L47332172A / KM5212341H02	Demarcation Strip	L:197, W:47, T: 22T.
TBS21005	L47332172B / KM5212341H01	Demarcation Strip	L:197, W:47, T: 22T.
TBS21006	L47332173A / KM5212340H01	Demarcation Strip	L:152, W:47, T: 17T.
TBS21007	L47332175A / KM5212347H01	Demarcation Strip	L:197, W:33, T: 22T.
TBS21008	L47332175B / KM5212347H02	Demarcation Strip	L:197, W:33, T: 22T.
TBS21009	L47332176A / KM5212343H01	Demarcation Strip	L:158, W:33, T: 17T.
TBS21010	L47332174A / KM5212344H01	Demarcation Strip	L:404, W:27.
TBS21011	L47332174B / KM5212344H02	Demarcation Strip	L:404, W:27.
TBS21016		Polyurethane Roller	Φ70X25 ID:20
TBS21017		Iron Hub	Φ150/153X36*35
TBS21018		Friction Wheel	
TBS21019		Roller Assembly	
TBS21020		Roller	70*36 6202 ID:15
TBS21021		Joint Strip	

Toshiba Escalator Parts



Escalator



TBS21027 TBS21028 TBS21029 TBS21030 TBS21031 TBS21032 TBS21033



TBS21035 TBS21036 TBS21037 TBS21039



TBS21040 TBS21041 TBS21042 TBS21043



TBS21044 TBS21045 TBS21048

GNL Model	Toshiba OEM /Model	Product Name	Product Description
TBS21027	5PSC0005P1,5PSC0005P2	Inlet Cover	C:Black, L:132.5, W:110.5/80.5, Thick:3
TBS21028	5PSC0005P3,5PSC0005P4	Inlet Cover	C:Black, L:132.5, W:80.5/110.5, Thick:3
TBS21029		Inlet Cover	C:Black, L:287,W:103.5, Thick:10
TBS21030		Inlet Cover	C:Black, L:287, W:202, Thick:10
TBS21031	0215CBJ001	Rubber Inlet	
TBS21032		Comb Plate	
TBS21033		Comb Plate	
TBS21035		Comb Plate	C:Yellow, L:205.6, H.D:145, T:22.
TBS21036		Comb Plate	C:Yellow, L:199.7, H.D:145, T:22.
TBS21037		Comb Plate	C:Yellow, L:202, H.D:140, T:22.
TBS21039	5PSP0003 P002	Comb Plate	C:Black, L:115, H.D:65, T:12.
TBS21040		Comb Plate	L:199.5, H.D:145, D:Side
TBS21041		Comb Plate	L:204, H.D:145, D:Center
TBS21042		Comb Plate	L:199.5, H.D:145, D:Side
TBS21043	5P1P5171-1	Comb Plate	C:Black, L:197.8, H:152, H.D:145, T:22.
TBS21044	5P1P5171-2	Comb Plate	C:Black, L:203, H:152, H.D:145, T:22.
TBS21045	5P1P5171-3	Comb Plate	C:Black, L:203, H:152, H.D:145, T:22.
TBS21048	5PSP0003 P001	Comb Plate	C:Black, L:127, H:77, T:14.



Hyundai Escalator Parts

Escalator



HNS23001



HNS23002



HNS23003



HNS23004



HNS23005



HNS23006

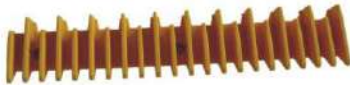

HNS23007



HNS23008



HNS23009



HNS23010



HNS23011



HNS23012



HNS23013



HNS23014



HNS23015

GNL Model	Hyundai OEM /Model	Product Name	Product Description
HNS23001	HE645B023 HO	Demarcation Strip	
HNS23002	HE645B023 HO	Demarcation Strip	
HNS23003	L47332130A	Demarcation Strip	
HNS23004	L47332130B	Demarcation Strip	
HNS23005	H645B028H06	Demarcation Strip	
HNS23006	H645B028H05	Demarcation Strip	
HNS23007	H645B029H02	Demarcation Strip	
HNS23008	H645B028H01	Demarcation Strip	
HNS23009	L57332056A	Demarcation Strip	
HNS23010	S645C606H01	Demarcation Strip	
HNS23011	S645C606H01	Demarcation Strip	
HNS23012	L57332060A	Demarcation Strip	
HNS23013	S645C605H01	Demarcation Strip	
HNS23014	645B025H01	Demarcation Strip	
HNS23015	L57332199/03B	Demarcation Strip	

Hyundai Escalator Parts



Escalator



HNS23016



HNS23017



HNS23018



HNS23019



HNS23020



HNS23021



HNS23024



HNS23025



HNS23026



HNS23027



HNS23028



HNS23029



HNS23030



HNS23031

GNL Model	Hyundai OEM /Model	Product Name	Product Description
HNS23016	L57332061A	Demarcation Strip	
HNS23017	S655B6	Comb Plate	L:154, H:92, 13T
HNS23018	S655B6	Comb Plate	L:155, H:92, 17T
HNS23019	S655B6	Comb Plate	L:154, H:92, 13T
HNS23020	HE655B013H06	Comb Plate	16 Teeth
HNS23021		Comb Plate	17T, 155*92 HD=107mm
HNS23024		Comb Plate	12T, 155*92 HD=89mm
HNS23025		Comb Plate	12T, 155*92 HD=80mm
HNS23026	613C001G01	Driving Roller	135*34 ID:44.8
HNS23027	S613C020	Handrail Roller	87*42 6204 ID:20
HNS23028		Driving Roller	149*36
HNS23029		Step Roller	76*25 6204
HNS23030	S650C607	Step Roller	76*25 6204
HNS23031		Step	



FUJITEC Escalator Parts

Escalator



GNL Model	FUJITEC OEM /Model	Product Name	Product Description
FUS18001	5P1P5582P001 0129CAC001	Demarcation Strip	L:202.6 , T.P:9.068 , W:49.5
FUS18002	5P1P5581P001 0129CAA001	Demarcation Strip	L:402 , T:32.5 , W:109
FUS18003	5P1P5581P002 0129CAB001	Demarcation Strip	L:402 , T:32.5 , W:96.6
FUS18004	0129CAA001	Demarcation Strip	L:402.5 , T:33.5 , W:109.2
FUS18005	0129CAB001	Demarcation Strip	L:402.5 , T:33.5 , W:96
FUS18006	0129CAC001	Demarcation Strip	L:203 , W:49.5 , T:15.6 , T.P:9.07
FUS18008		Gliding Bushing	
FUS18009		Aluminum Step	
FUS18010		Aluminum Step with Demarcation Strip	
FUS18012		Nylon Aluminum Hub Handrail Roller	70*50 6204
FUS18013		Roller	Φ75X23.5 6204 ID:20
FUS18014		Nylon Hub Roller	Φ75X23.5 ID:20.1
FUS18015		Pulley	OD:32
FUS18016		Handrail press roller	70*75 6004
FUS18017		Inlet Cover	L:371,, W:240,, Tness:125,
FUS18018		Inlet Cover	L:371,, W:240,, Tness:125
FUS18019		Rubber Inlet	
FUS18020		Hairbrush	
FUS18022		Friction Pulley	OD:440*36. MODIFY, ID:250
FUS18025	0129CAD001	Comb Plate	L:199.4 , H.S:145 , T.P:9.068
FUS18026	0129CAE001	Comb Plate	L:202.9 , H.S:135.8 , T.P:9.068
FUS18027	0129CAF001	Comb Plate	L:202.9 , H.S:130 , T.P:9.068 ,
FUS18028	0129CAP001	Comb Plate	L:199.4 , H.S:72.5 , T.P:9.068
FUS18029	0129CAR001	Comb Plate	L:202.9 , H.S:67.5 , T.P:9.068
FUS18030	0129CAS001	Comb Plate	L:202.9 , H.S:65.8 , T.P:9.068
FUS18031		Reversing Chain	P.L:60 , W:34 L:1100
FUS18032		Chain Link	
FUS18033		Chain	Roller Size 75*23.5, T133.33

HITACHI Escalator Parts



Escalator



HCS16001



HCS16002



HCS16003



HCS16004



HCS16005



HCS16006



HCS16007



HCS16008



HCS16009

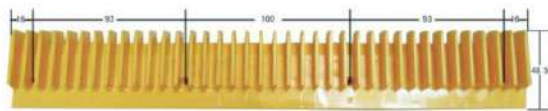

318×48.5×38

LDTJ-A-10B

HCS16010

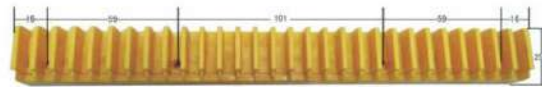

251×25.5×30

LDTJ-B-13

HCS16011



HCS16012



HCS16013



HCS16014



HCS16015



HCS16016

GNL Model	HITACHI OEM /Model	Product Name	Product Description
HCS16001	LL27332044	Demarcation Strip	
HCS16002	32188939-C	Demarcation Strip	Center
HCS16003	LL27332044	Demarcation Strip	
HCS16004	H2106230 (Orange H2106232)	Demarcation Strip	L:411, T:18.7, W:24.7
HCS16005	H2106231 (Orange H2106233)	Demarcation Strip	L:411, T:18.7, W:24.7
HCS16006	H2106223, 9911007N	Demarcation Strip	L:319, T:25, W:25.3 Back
HCS16007	H2106211 (Orange H2106212),	Demarcation Strip	L:319, T:25, W:43.4 Front
HCS16008	L47332045B	Demarcation Strip	
HCS16009	L47332045A	Demarcation Strip	
HCS16010	LDTJ-A-16B,318*48.5*38	Demarcation Strip	
HCS16011	LDTJ-B-13,251*25.5*30	Demarcation Strip	
HCS16012	L47332114B,224*30	Demarcation Strip	
HCS16013	L47332114A,224*30	Demarcation Strip	
HCS16014		Wearing strip	
HCS16015		White Adhesive Tape	
HCS16016		Step	30/35 Degree Flat Tooth



HITACHI Escalator Parts

Escalator



HCS16017



HCS16018



HCS16019



HCS16020



HCS16021

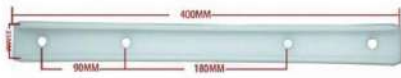

HCS16022



HCS16023



HCS16024



HCS16025



HCS16026



HCS16027



HCS16028



HCS16029



HCS16030



HCS16031



HCS16032



HCS16033



HCS16034



HCS16035

GNL Model	Fermator OEM /Model	Product Name	Product Description
HCS16017		Iron Step Roller	Φ80X23 6202 ID:15
HCS16018		Iron Chain Roller	Φ80X28 6202 Double Bearing ID:15
HCS16019		Iron Hub	Φ90X50 6204 ID:20
HCS16020		Driving Roller	141*36 ID:57
HCS16021		Iron Hub Roller	Φ90X60 6202
HCS16022		Handrail Guide	
HCS16023		Handrail Guide	
HCS16024		Travalater Comb Plate	
HCS16025	H2201346	Travalater Comb Plate	Center
HCS16026		Travalater Comb Plate	
HCS16027	H2200122	Comb Plate	L:164, H:90, H.S:90, T.P:8.4, Remark:Plastic, 19 Teeth,
HCS16028	H2200116	Comb Plate	L:142, H:90, H.S:90, T.P:8.4, Remark:Plastic, 17 Teeth, Center
HCS16029	H2200124	Comb Plate	L:164, H:90, H.S:90, T.P:8.4, Remark:Plastic, 19 Teeth,
HCS16030		Comb Plate	L:163.5, H.S:90, T.P:8.7, Remark:Iron Base Polyurethane
HCS16031		Comb Plate	L:163.5, H.S:90, T.P:8.7, Remark:Iron Base Polyurethane
HCS16032		Comb Plate	L:200.7, H.S:99, T.P:8.7, Remark:Iron Base Polyurethane Center
HCS16033	L47312017A&B	Comb Plate	
HCS16034	L47312018A&B	Comb Plate	
HCS16035	L47312013A LDTJ-B-3	Comb Plate	Center

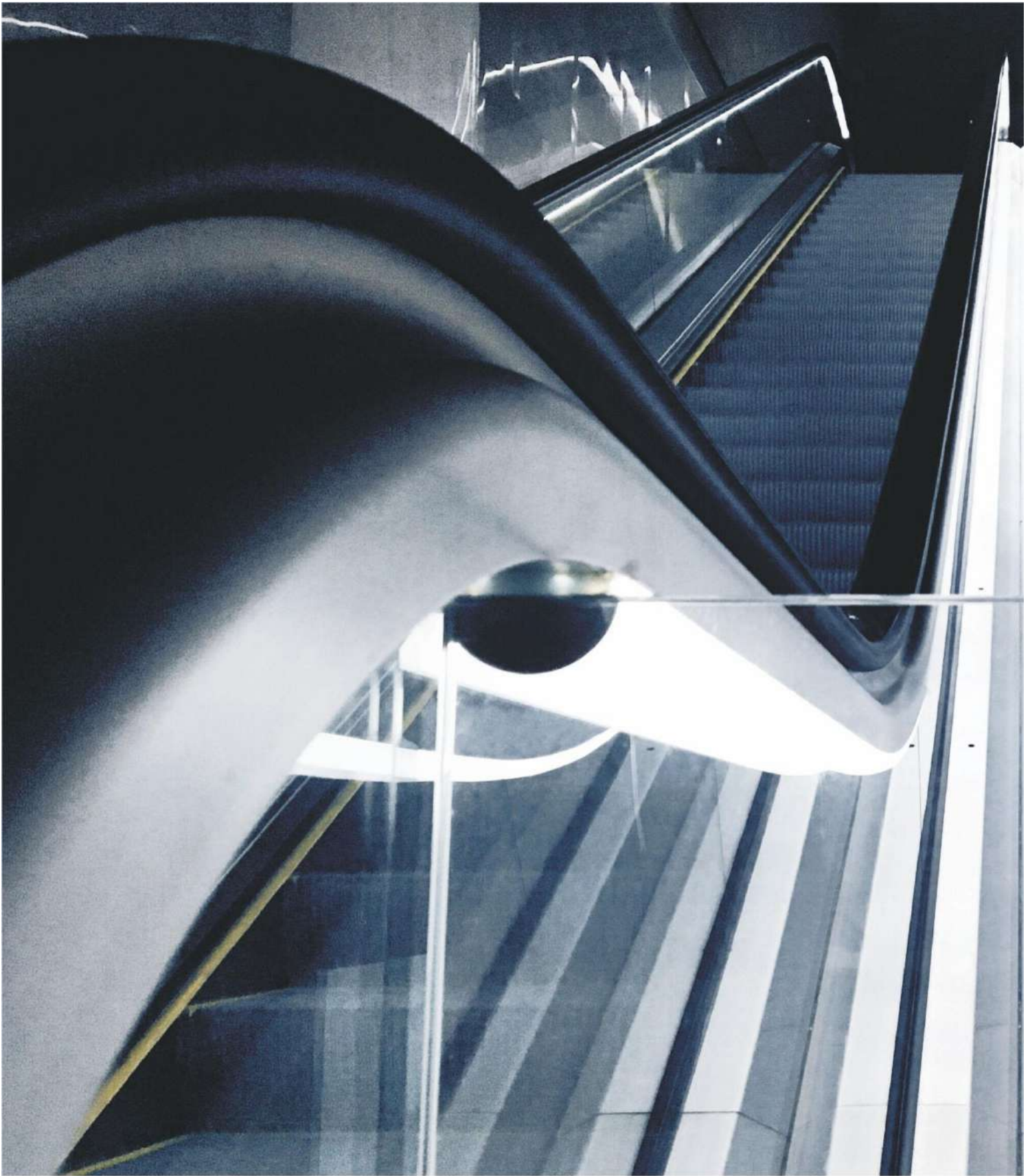

Ningbo GNL Elevator Spare parts Co.,Ltd

Address : R107,A BLDG,NO.2,Shichuang RD,
Zhenhai Dist,Ningbo City,China
E-mail : max@gnlint.com
WWW.GNLINT.COM

Mob & WhatsApp : 0086-15869595440
Phone : 057455681351
Fax : 057455681351